



# SMART Board® GX (V2) series interactive displays

## User guide

SBID-GX165-V2 | SBID-GX175-V2 | SBID-GX186-V2  
IDGX65-2 | IDGX75-2 | IDGX86-2



Was this document helpful?  
[smarttech.com/docfeedback/171862](https://smarttech.com/docfeedback/171862)

**SMART**®

## Learn more



This guide and other resources for SMART Board GX (V2) series interactive displays are available in the Support section of the SMART website ([smarttech.com/support](http://smarttech.com/support)). Scan this QR code to view these resources on your mobile device.



ENERGY STAR is the government-backed symbol for energy efficiency, providing simple, credible, and unbiased information that consumers and businesses rely on to make well-informed decisions. ENERGY STAR-certified products are the simple choice for energy efficiency, making it easy for consumers and businesses to make purchases that save them money and protect the environment. The U.S. EPA ensures that each product that earns the label is independently certified to deliver the quality, performance, and savings that users have come to expect.

As shipped, your display delivers ENERGY STAR performance and savings. However, changing some settings may increase energy consumption beyond the limits required for ENERGY STAR certification. For example, increased brightness and contrast will increase power consumption.

Please consider the environment when you choose non-ENERGY STAR settings.

### Licenses



The terms HDMI, HDMI High-Definition Multimedia Interface, HDMI trade dress and the HDMI Logos are trademarks or registered trademarks of HDMI Licensing Administrator, Inc.

The Bluetooth word mark is owned by the Bluetooth SIG, Inc. and any use of such marks by SMART Technologies ULC is under license.

### Trademark notice

SMART Board, SMART Notebook, SMART TeamWorks, SMART Meeting Pro, Object Awareness, Silktouch, smarttech, the SMART logo and all SMART taglines are trademarks or registered trademarks of SMART Technologies ULC in the U.S. and/or other countries. The Bluetooth word mark is owned by the Bluetooth SIG, Inc. and any use of such marks by SMART Technologies ULC is under license. The Adopted Trademarks HDMI, HDMI High-Definition Multimedia Interface, and the HDMI Logo are trademarks or registered trademarks of HDMI Licensing Administrator, Inc. in the United States and other countries. Microsoft and Windows are either registered trademarks or trademarks of Microsoft Corporation in the United States and/or other countries. All other third-party product and company names may be trademarks of their respective owners.

### Copyright notice

© 2023 SMART Technologies ULC. All rights reserved. No part of this publication may be reproduced, transmitted, transcribed, stored in a retrieval system or translated into any language in any form by any means without the prior written consent of SMART Technologies ULC. Information in this manual is subject to change without notice and does not represent a commitment on the part of SMART.

This product and/or use thereof is covered by one or more of the following U.S. patents:

[www.smarttech.com/patents](http://www.smarttech.com/patents)

March 15, 2023

# Important information

## Note

Refer to the *SMART Board GX (V2) series interactive displays installation and maintenance guide* ([smarttech.com/kb/171861](https://smarttech.com/kb/171861)) for important information about installing and maintaining the display.

## Warning

- Do not open or disassemble the display. You risk electrical shock from the high voltage inside the casing. Opening the casing also voids the warranty.
- Do not stand (or allow children to stand) on a chair to touch the surface of the display.
- To reduce the risk of fire or electric shock, do not expose the display to rain or moisture.
- Do not insert objects inside the cabinet ventilation holes, because they could touch dangerous voltage points and cause electric shock, fire, or product damage which may not be covered by the warranty.
- Do not place heavy objects on the power cable. Damage to the cable could cause shock, fire, or product damage which may not be covered by the warranty.
- If the glass is broken, do not touch the liquid crystal. To prevent injury, handle glass fragments with care when disposing of them.
- Disconnect the display's power cable from the wall outlet and seek assistance from qualified service personnel if any of the following occur:
  - The power cable or plug is damaged
  - Liquid is spilled into the display
  - Objects fall into the display
  - The display is dropped
  - Structural damage, such as cracking, occurs
  - The display behaves unexpectedly when you follow operating instructions
- This product may contain substances that are candidate SVHCs under the EU REACH Regulation (EC) 1907/2006. Check <https://echa.europa.eu/scip-database> for the latest information.

# Contents

<b>Important information</b>	<b>3</b>
<b>Chapter 1 Welcome</b>	<b>6</b>
About this guide	6
About the display	7
Identifying your specific model	10
Accessories	11
More information	12
<b>Chapter 2 Using basic features</b>	<b>13</b>
Waking the display and putting it in standby	13
Using the front control panel	14
Using the remote control	15
On-screen menus and controls	18
Using touch	23
Writing, drawing, and erasing	24
Freezing the screen	26
<b>Chapter 2 Using apps on the display</b>	<b>27</b>
Using Whiteboard	29
Using Browser	37
Using Screen Share	38
Using Palette	58
Using Camera	61
Using Clean	65
Using Cloud Drive	66
Using WPS Office	67
Using File manager	67
Using SMART Remote Management	72
Using Settings	72
Unsupported apps	72
<b>Chapter 3 Using widgets on the display</b>	<b>74</b>
Input Settings menu	76
Using the Overlay widget	76
Using the Timer widget	78
Using Stopwatch	80
Using the Spotlight widget	82

## Contents

Using the Record widget .....	83
Using the Freeze widget .....	85
Using the PIP widget .....	86
Using the Split screen widget .....	87
Using Screen lock .....	88
Using the Calculator tool .....	88
Using the Screen Capture widget .....	89
<b>Chapter 4 Connecting computers and other devices .....</b>	<b>91</b>
Installing and using SMART software .....	91
Connecting room computers and guest laptops .....	92
Connecting a SMART OPS PC module .....	103
Connecting USB drives, peripherals, and other devices .....	104
<b>Chapter 5 Troubleshooting the display .....</b>	<b>105</b>
Resolving general issues .....	105
The display isn't turning on .....	106
The display is turning off when it shouldn't .....	106
The screen is blank or there's a problem with the image on the screen .....	107
There's no sound or there's a problem with the sound .....	109
Touch isn't working as expected .....	110
The pens aren't working as expected .....	111
SMART software on connected computers isn't working as expected .....	112
The SMART OPS PC module isn't working as expected .....	112
Contacting your reseller for additional support .....	112
<b>Chapter 6 Troubleshooting tools and apps .....</b>	<b>114</b>
Resolving issues with Whiteboard .....	114
Resolving issues with Browser .....	115
Resolving issues with Screen Share .....	116
Resolving issues with File Manager .....	117
<b>Certification and compliance .....</b>	<b>118</b>

# Chapter 1 **Welcome**

- About this guide ..... 6
- About the display ..... 7
  - Touch ..... 7
  - Display ..... 7
  - Mounting hardware ..... 8
  - Front control panel ..... 8
  - Remote control and infrared sensor ..... 8
  - Ambient light sensor ..... 8
  - Power status ..... 8
  - Writing, drawing, and erasing ..... 8
  - Audio ..... 9
  - Network connectivity ..... 9
  - Front connector panel ..... 9
  - Room computers and guest laptops ..... 9
  - Tools and features ..... 10
  - Accessory slot ..... 10
- Identifying your specific model ..... 10
- Accessories ..... 11
  - SMART OPS PC module ..... 11
  - Stands ..... 11
  - USB extenders ..... 12
- More information ..... 12

---

The SMART Board® GX (V2) series interactive display gives you everything you need to get started with interactivity. This chapter introduces the features of your GX (V2) series display.

## About this guide

This guide explains how to use SMART Board GX (V2) series interactive displays.

This guide is for people who use SMART Board interactive displays. Documentation and resources for those who install and maintain displays is also available (see *More information* on page 12).

# About the display

The SMART Board GX (V2) series gives you everything you need to get started with interactivity.

The display includes a comprehensive set of features and components.

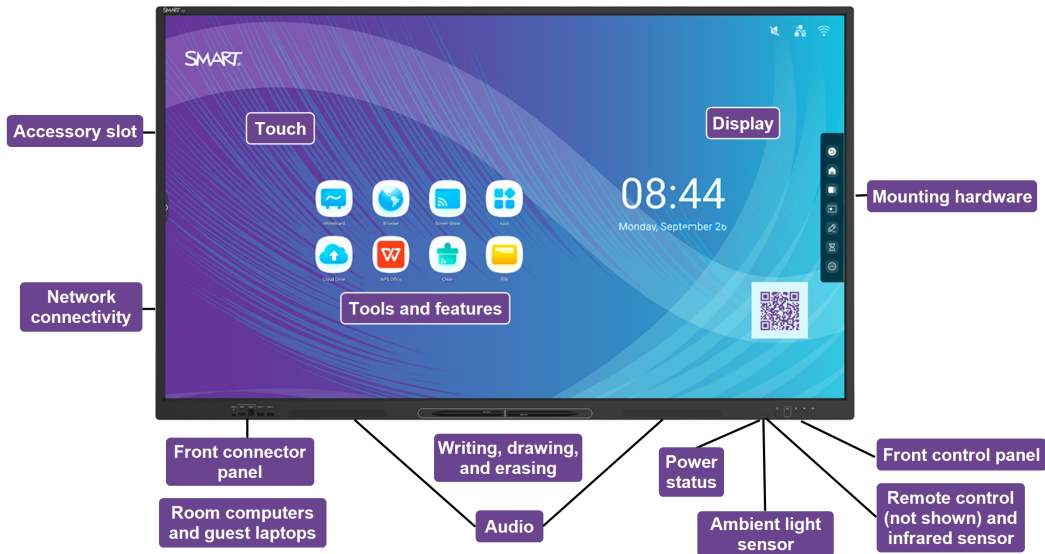

## Touch

You can do everything on the display that you can do at your computer—open and close applications, meet with others, create new documents or edit existing ones, visit websites, play and manipulate videos, and so on—by touching the display’s surface.

You can use an array of gestures within applications, including panning, scaling, rotating, and zooming in and out.

For more information, see *Using touch* on page 23.

## Display

The 4K ultra-high-definition LED display provides optimal image clarity and wide viewing angles.

The display size varies by model:

Models	Size (diagonal)
SBID-GX165-V2	65"
SBID-GX175-V2	75"
SBID-GX186-V2	86"

## Mounting hardware

You can use VESA compliant wall mounts, such as SMART's WM-SBID-200 wall mount (not included), to mount the display on a wall.

You can also mount the display on a mobile stand (see *Accessories* on page 11).

## Front control panel

The front control panel provides buttons for turning the display on and off, controlling the volume, freezing the screen, and displaying the Home screen.

For more information about the front control panel, see *Using the front control panel* on page 14.

## Remote control and infrared sensor

The display's infrared sensor is located in the control panel in the bottom-right corner of the display's frame.

You can use the remote control to turn the display on and off, adjust display settings, and so on.

For more information, see *Using the remote control* on page 15.

## Ambient light sensor

The ambient light sensor is located in the bottom-right corner of the display's frame. The sensor detects the brightness of the room and adjusts the screen's brightness accordingly.

To enable or disable this feature, go to **Input > Advanced settings > Screen > AutoLight**.

See the *SMART Board GX (V2) series interactive displays installation and maintenance guide* ([smarttech.com/kb/171861](http://smarttech.com/kb/171861)).

## Power status

The power status indicator light is located in the Power button in bottom-right of the display's frame.

For more information, see *Using the front control panel* on page 14.

## Writing, drawing, and erasing

The display comes with two pens you can use to write or draw on the screen. Each end of a pen can be assigned to write or draw in a different color when using the Whiteboard app. You can erase digital ink by moving your fist or palm over the digital ink.



With Object Awareness<sup>1</sup>, the display responds automatically to the tool or object you're using, whether it's a pen, finger, or palm.

For more information, see *Writing, drawing, and erasing* on page 24.

## Audio

The display includes two 20 W integrated speakers.

## Network connectivity

The display requires a network and internet connection for downloading software and firmware updates. Some applications also require a network and internet connection (for example, the web browser).

The display requires a network and internet connection for downloading software and firmware updates.

You can connect the display to a network using Wi-Fi or an Ethernet cable.

- The Wi-Fi module supports both 2.4 and 5 GHz bands.
- The two RJ45 jacks allow you to connect the display and an external device, such as a computer, to an Ethernet network.

See the *SMART Board GX (V2) series interactive displays installation and maintenance guide* ([smarttech.com/kb/171861](http://smarttech.com/kb/171861)).

## Front connector panel

The front connector panel includes connectors for USB peripherals and a computer or other input.

For more information, see *Connecting room computers and guest laptops* on page 92 and *Connecting USB drives, peripherals, and other devices* on page 104.

## Room computers and guest laptops

You can connect room computers and guest laptops to the display and view and interact with them.

The display comes with SMART software that you can install on connected computers to take full advantage of the display's features.

For more information, see *Connecting room computers and guest laptops* on page 92.

---

<sup>1</sup>When connected to a computer with SMART Product Drivers

## Tools and features

The display's built-in Android™ computing provides apps that enable you to browse the web, use a whiteboard, share your screen, and more without using a connected device.

For more information, see *Chapter 2 Using apps on the display* on page 27.

## Accessory slot

You can install an OPS-compatible device, such as a SMART OPS PC module, in the accessory slot. SMART OPS PC modules provide a complete Windows® Pro installation.

For more information about SMART OPS PC modules, see *SMART OPS PC module* on the next page.

### **Caution**

- The accessory slot's maximum available power is 100 W. The slot is not a limited power source. To reduce the risk of fire, make sure that accessories connecting to the slot satisfy the fire enclosure requirements of IEC 62368-1.
- Do not remove the OPS PC or other devices from the accessory slot while they are turned on.
- Do not install or remove the OPS PC or other devices in the accessory slot while the display is turned on.

## Identifying your specific model

SMART offers several models of the SMART Board GX (V2) series interactive displays.

For help identifying your model, see the labels on the back or left side of the display.

### **Tip**

The label features the display's base model number (for example, SBID-GX075-V2). Please note this number is different from the actual model/SKU number (for example SBID-GX175-V2).

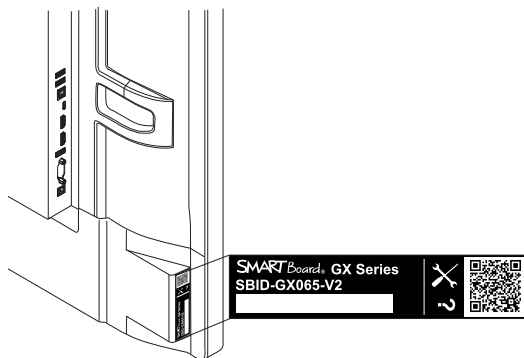

Model	Screen size (approximate)
SBID-GX165-V2	65" (165 cm)
SBID-GX175-V2	75" (190 cm)
SBID-GX186-V2	86" (218 cm)

## Accessories

Accessories for the display include:

- SMART OPS PC module
- SMART wall mount (WM-SBID-200) for SMART Board displays
- Stands
- USB extenders

### Note

For more information about these and other accessories, see [smarttech.com/accessories](http://smarttech.com/accessories).

## SMART OPS PC module

SMART Open Pluggable Specification (OPS) PC modules provide a hassle-free Windows Pro installation based on Intel® Core™ processors and are designed specifically to work with a SMART Board interactive display. All OPS PC modules are fully licensed with Windows Pro. Install the OPS PC module in a display's accessory slot to provide a complete 4K UHD Windows installation at your fingertips, without the need for an external PC or additional cables.

Install familiar Windows applications, such as SMART Notebook®, SMART TeamWorks™, and SMART Meeting Pro® software, and access the internet directly through your display's network connection. Upgrades and service for the OPS PC module are easy to perform without removing the display from its mounting.

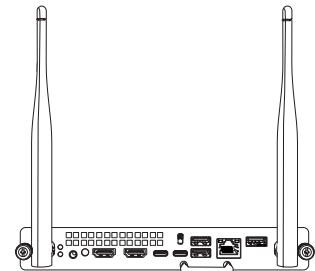

## Stands

If you want to move the display from place to place, you can install it on a SMART mobile stand. If you are installing the display on a wall that cannot support the display's full weight, you can install the display on a SMART floor stand.

### Note

If you want to use the 86" model (SBID-GX186-V2) with a variety of SMART's electric height-adjustable stands, you must first attach a SMART wall mount (model WM-SBID-200, part #1031766, [smarttech.com/kb/171405](http://smarttech.com/kb/171405)) to the display before mounting the display to the stand. (This applies to the FSE-400, FSE-410, and FSE-420 models of mobile stand and the WSE-400 and WSE-410 models of wall stand).

## USB extenders

As noted in the display's specifications, the USB connection between the display and computer should be no longer than 16' (5 m). If you need to connect a computer that is more than 16' (5 m) from the display, use the following USB extender:

Extender	Specifications
USB-XT	<a href="http://smarttech.com/kb/119318">smarttech.com/kb/119318</a>

### Note

For more information about extending USB connections, see [USB cable extenders](#).

## More information

SMART provides a variety of other documents for this display in the Support section of the SMART website ([smarttech.com/support](http://smarttech.com/support)). Scan the QR code on this guide's cover for links to SMART Board GX (V2) series interactive display documents and other support resources.

# Chapter 2 Using basic features

Waking the display and putting it in standby .....	13
Using the front control panel .....	14
Using the remote control .....	15
On-screen menus and controls .....	18
Notification icons (network, audio, and so on) .....	18
Side Toolbar buttons .....	19
Toolbar .....	19
Favorite widget shortcuts .....	21
Shortcuts .....	21
Adding shortcuts to the Home screen .....	21
Managing shortcuts .....	22
Apps .....	23
Swipe-up menu .....	23
Using touch .....	23
Writing, drawing, and erasing .....	24
Writing and drawing in digital ink .....	25
Erasing digital ink .....	25
Using the SMART Ink dynamic (floating) toolbar .....	26
Changing a pen's default color, thickness, and other properties .....	26
Freezing the screen .....	26

---

## Waking the display and putting it in standby

If the display is in Standby mode, you can wake it by pressing the **Power** button  on the front control panel or remote control.

To return the display to Standby mode, press and hold the **Power** power button  on the front control panel for three seconds to begin a 10 second countdown before the display enters Standby mode.

OR

Press the **Power** power button  on the remote control to begin a 10 second countdown before the display enters Standby mode.

**Note**

When the display is connected to an external input that has had no active signal for 5 minutes, it begins a 10 second countdown before it enters Standby mode.

For information about turning off the display, see the *SMART Board GX (V2) series interactive displays installation and maintenance guide* ([smarttech.com/kb/171861](http://smarttech.com/kb/171861)).

## Using the front control panel

The front control panel contains buttons for turning the display on and off, controlling the volume, freezing and unfreezing the screen, and going to the Home screen.

The front control panel also includes a light that indicates the display's current power state.

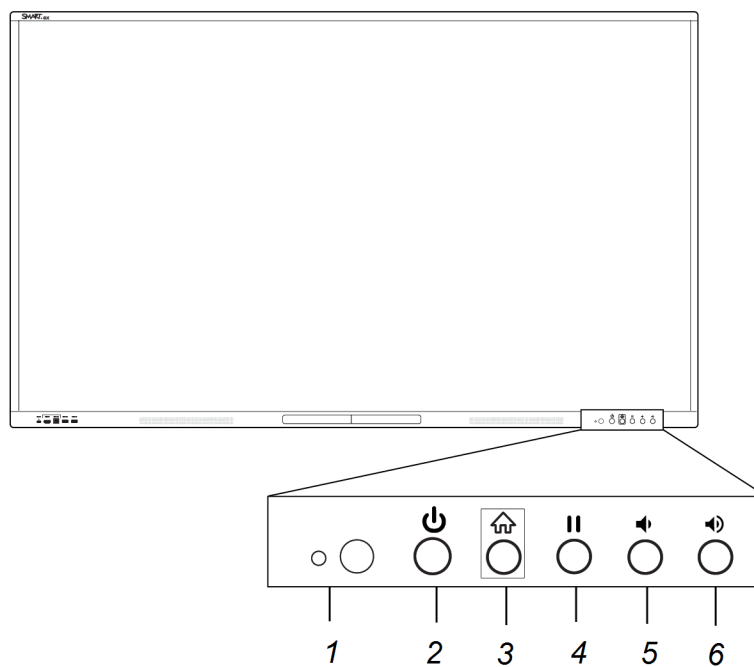

No.	Name	Procedure
1	Remote control receiver and ambient light sensor	[N/A]

No.	Name	Procedure
2	Power, and status light	<ul style="list-style-type: none"> <li>Enter or exit Ready mode.</li> <li>Press and hold for three seconds to begin a 10 second countdown before the display enters Standby mode.</li> </ul>
3	Home	Return to the Home screen.
4	Freeze	Freeze and unfreeze the screen.
5	Volume decrease	Decrease the volume.
6	Volume increase	Increase the volume.

The Power button's color indicates the display's status:

Power button	Display status
Off	Not receiving power
Red (solid)	Standby mode
Red/blue (blinking, slow)	Ready mode
Blue	Normal operating mode
Red/blue (flashing, rapid)	Background process running (for example, a firmware update is in progress or display is turning off)

## Using the remote control

Use the remote control to turn the display on or off, change the input, control the volume, and more. You can also use the remote control to open the on-screen menus and change the display's settings.

### Important

- Do not subject the remote control to strong shock.
- Keep the remote control away from liquids. If it gets wet, wipe it dry immediately.
- Do not expose the remote control to heat or steam.
- Do not open any part of the remote control other than the battery compartment.

This image and table list the remote control's functions.

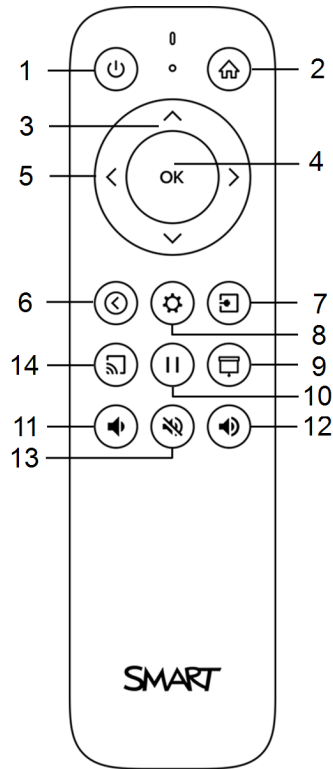

No.	Name	Description
1	Power	Press to begin a 10-second countdown before the display enters Standby mode.
2	Home	Open the Home screen.
3	Up and down buttons	Move selection up or down.
4	OK	Select a menu option in the settings, or enable selected items in apps.
5	Left and right buttons	Move selection left or right.
6	Back	Return to the previous item in the current application or to the previous application.
7	Input	Switch inputs.



<b>No.</b>	<b>Name</b>	<b>Description</b>
8	Settings	Show or hide display settings menu while viewing the Home screen. Show or hide the Input settings dialog when viewing a connected input.
9	Screen shade	Hide screen contents behind a screen shade.
10	Freeze frame	Freeze and unfreeze the screen.
11	Volume increase	Increase the volume.
12	Volume decrease	Decrease the volume.
13	Volume mute	Mute the volume.
14	Share screen	Show or hide the screen share floating connection code information bar.

# On-screen menus and controls

The SMART Board GX (V2) series display features a number of on-screen menus and controls.

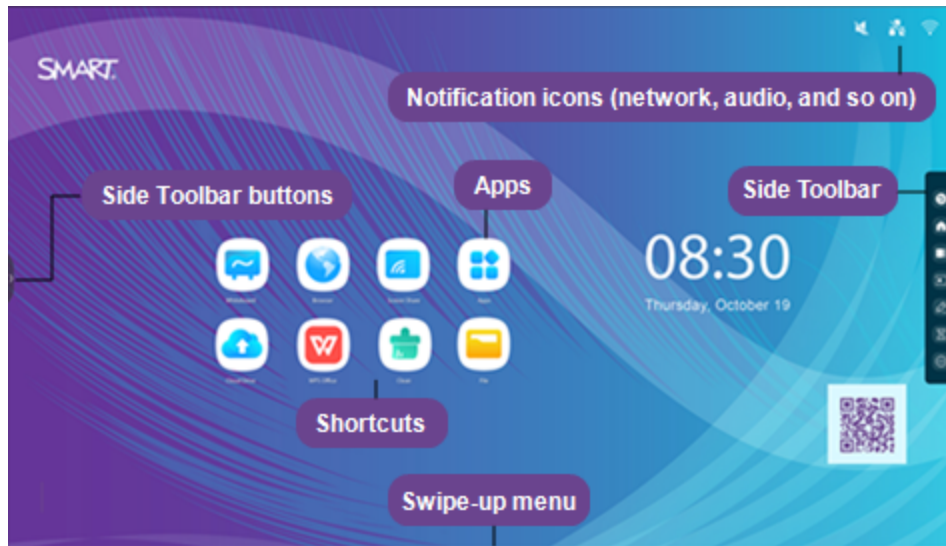

## Notification icons (network, audio, and so on)

The notification icons provide information about the display's network connection, speaker status, and connected USB drives.

Icon	Description	Notes
	Connected to a wireless network and signal strength	The Wi-Fi signal strength being received by the display. Tap the icon to open the Wi-Fi settings.
	Disconnected from a wireless network	Indicates the display is not connected to a wireless network.  <b>Note</b> The display cannot connect to an Ethernet and wireless network simultaneously. Tap to open the Wi-Fi settings page.
	Connected to a wired network	Indicates the display is connected to an Ethernet network.
	Disconnected from a wired network	Indicates the display is not connected to an Ethernet network.
	Speakers are on	The display's speakers are turned on.
	Speakers are off	The display's speakers are turned off.

Icon	Description	Notes
	USB drive connected	Indicates a USB drive is connected to the display. Tap the icon to open a connected USB drive in File Manager.

## Side Toolbar buttons

See *Toolbar* below.



## Toolbar

From the Toolbar, you can access a number of commonly used display controls and widgets, including the widgets menu.

To open the **Toolbar**, tap either of the side Toolbar menu buttons  on either side of the screen.



No.	Command	Description	Notes
1	Back	Return to the previous screen or menu item in the embedded Android system.	[N/A]
2	Home	Open the Home screen.	[N/A]

No.	Command	Description	Notes
3	Task view	<p>Shows a preview tile of each running app. Swipe up or down to view all running apps.</p> <p><b>To open a running app</b></p> <p>Tap the tile to open the selected item or tap the <b>Back</b> icon  in the Toolbar menu to return to the current screen.</p> <p><b>Tip</b></p> <p>Tap the <b>Split screen</b> icon  in the top-right corner of an app's tile to see a list of apps that can be opened in split screen mode with the app.</p> <p><b>To close an app</b></p> <p>Tap the <b>Close</b> icon  to close an app.</p> <p><b>Tip</b></p> <p>You can also press and hold then left-swipe an app to close it</p> <p>OR</p> <p>Tap <b>Close all tasks</b> to close all running apps.</p>	<p>See the <i>SMART Board GX (V2) series interactive displays installation and maintenance guide</i> (<a href="http://smarttech.com/kb/171861">smarttech.com/kb/171861</a>)</p>
4	Favorite widgets	<p>If you have a widget that you use regularly, you can pin it to the Tool bar menu to make it easy to find from the Home screen.</p>	<p>See <i>Favorite widget shortcuts</i> on the next page.</p>
5	More (widgets menu)	<p>In the widgets menu, you can access the calculator, timer, stopwatch, and other tools.</p>	<p>See <i>Chapter 3 Using widgets on the display</i> on page 74.</p>

### **Favorite widget shortcuts**

You can pin up to four of your favorite widgets to the Toolbar to make them easier to find from the Home screen.

#### **To pin a widget to the Toolbar**

1. Open the Toolbar (see *Toolbar* on page 19).
2. Tap the **More** icon .  
The widgets menu appears.
3. Tap **Edit** or tap and hold on any widget icon until the + and – symbols appear next to the widget icons.
4. Tap + or press and drag a widget to pin it to the Toolbar.  
You can pin a maximum of four widgets to the Toolbar.

#### **To remove a widget from the Toolbar**

1. Open the Toolbar.
2. Tap the **More** icon .  
The widgets menu appears.
3. Tap **Edit** or press and hold any widget icon until the + and – symbols appear next to the widget icons.
4. Tap – or drag a widget back to the widgets menu.  
You can also tap **Reset** to display the default list of widgets in the Toolbar.

## **Shortcuts**

You can add shortcuts to your favorite apps, frequently used files, web pages, and more to make them easier to find on the Home screen.

### **Adding shortcuts to the Home screen**

You can add shortcuts to your favorite apps (see *Chapter 2 Using apps on the display* on page 27), frequently used files, web pages, and more to make them easier to find on the Home screen.



### **Tip**

To move a shortcut on the Home screen, press and hold the shortcut, then drag it to a new location.



### **To add an application shortcut**

1. From the Home screen, tap the **Apps** icon .
2. Press and drag an app to add it as a shortcut to the Home screen.

### **To add a web page shortcut**

1. Tap the **Browser** icon  and browse to a web page.
2. At the top right, tap the **More** icon .  
The options menu appears
3. Tap **Send the quick-link to Desktop**, type a name for the shortcut, and tap **Add**.  
The web page shortcut is added to the Home screen.

### **To add a file shortcut**

1. From the Home screen, tap the **Apps** icon .
2. Tap the **File Manager** icon  and browse to the file you want to add as a shortcut.
3. Tap on a file to select it, tap **Send** in the bottom menu, and then tap **Shortcut**.  
The file shortcut is added to the Home screen.

### **Managing shortcuts**

You can move or delete the shortcuts you've added to the Home screen.

### **To move a shortcut on the Home screen**

Press and hold a shortcut until its options menu appears, and then drag the shortcut to a new position on the Home screen.

### To delete a shortcut

1. Press and hold an app icon until the *Remove* option appears.
2. Tap **Remove**.

The app shortcut is removed from the Home screen.

## Apps

Open a menu of additional Android apps installed on the display, such as Palette, Camera, Clean, Cloud Drive, WPS Office, File manager, Settings, and SMART Remote Management.

## Swipe-up menu

Swipe up from the bottom edge of the screen to open the Toolbar menu (see *Toolbar* on page 19) or Input settings menu, depending on the current Swipe-up menu setting.

For more information about changing the swipe up settings, see the **Display settings > Personalization** section of the *SMART Board GX (V2) series interactive displays installation and maintenance guide* ([smarttech.com/kb/171861](http://smarttech.com/kb/171861)).

## Using touch

You can do everything on the display that you can do at your computer—open and close applications, meet with others, create new documents or edit existing ones, visit websites, play and manipulate videos, and so on—by touching the display’s surface.

### Note

Some applications don’t support all the gestures. Not all gestures work in all applications. Refer to an application’s documentation to learn which gestures it supports.

*Pan (one finger)*

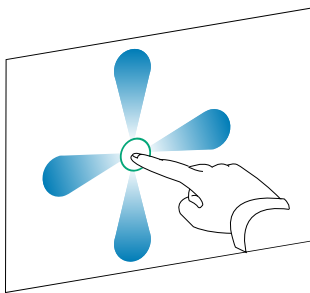

*Pan (two fingers) / scroll*

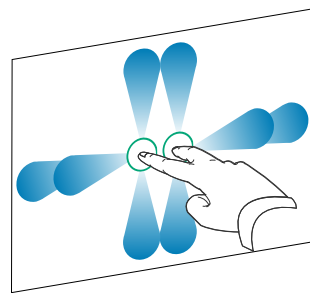

*Pinch to zoom in / scale (enlarge)*

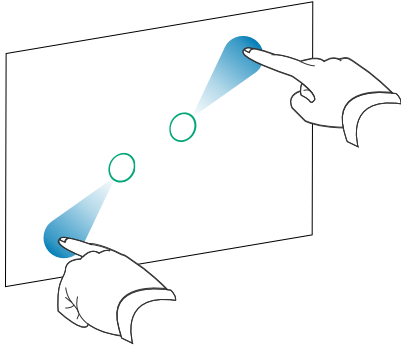

*Pinch to zoom out / scale (reduce)*

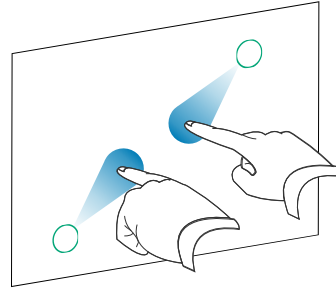

*Rotate*

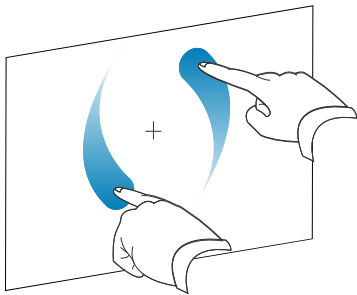

*Flick*

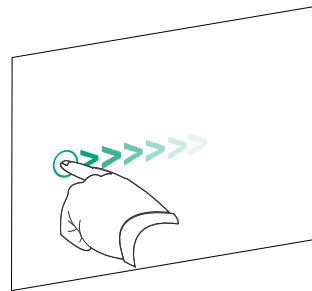

*Erase with palm*

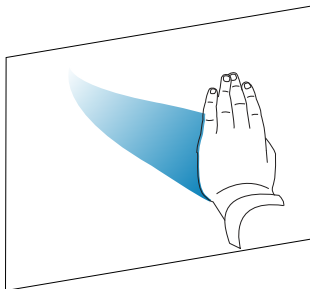

*Erase with fist*

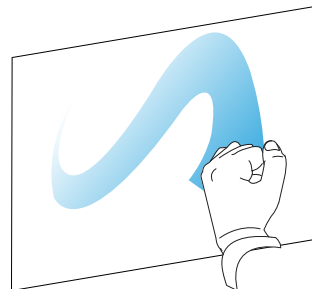

## Writing, drawing, and erasing

The display comes with two pens, which you can use to write or draw in digital ink. Each pen has a thin nib and a thick one. The default pen behavior, including writing style and ink color, varies by application.

The display has magnetic holders for the pens at the bottom of the display's frame. Return the pens to their holders when you're done with them.



**⚠ Caution**

When you return a magnetic pen to the holder, make sure it's centered in its holder to keep it from falling and being damaged.

## Writing and drawing in digital ink

1. Pick up one of the display's pens.
2. Write or draw in digital ink on the screen.

**! Important**

Use only pens designed for SMART Board GX (V2) series interactive displays. Pens for other SMART products aren't compatible with SMART Board GX (V2) series (see [Comparing SMART product pens](#)).

### Tips

- When writing, the smaller tip on the display's pens writes in digital ink and the larger tip acts as a finger or pointer. The action of the pen's larger tip will vary depending on which app is used on the display or connected computer.
- When writing or drawing in the Whiteboard app, you can change a pen's color, thickness, and writing style (see *Using Whiteboard* on page 29). When using the Overlay widget to write or draw on overlays, you can write or draw in pen or highlighter mode with color options available with each mode (or more information, see *Using the Overlay widget* on page 76).
- Use the *Pair mode* feature in the Whiteboard app (see *Pair mode* on page 32) to enable 2–4 participants to write or draw simultaneously in separately partitioned areas of the screen.

## Erasing digital ink

Move your palm or fist over digital ink to erase.

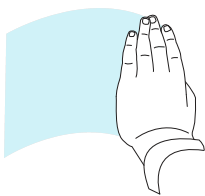

You can also use the eraser feature in some apps to change the display's pen tips to act as an eraser.

## Using the SMART Ink dynamic (floating) toolbar

If you touch a pen to the display's screen while viewing a connected computer's input, the SMART Ink® dynamic (floating) toolbar appears. You can use this toolbar to temporarily change the pen's color, thickness, or other properties, and you can also access SMART Ink's tools, such as screen capture, spotlight, screen shade, and so on.



To learn more about SMART Ink and its toolbar, visit the [SMART Ink support page](#). Here are a few quick links to get you started:

- [Turning SMART Ink on or off](#)
- [Opening the dynamic \(floating\) toolbar](#)
- [Closing \(hiding\) the toolbar](#)
- [Using SMART Ink presentation tools](#)

## Changing a pen's default color, thickness, and other properties

While you're viewing a connected computer's input, you can use the SMART Ink dynamic (floating) toolbar to change a pen's color, thickness, and other properties.

To change the pen's default color, thickness, and other properties, see [Changing pen, eraser, and button settings](#).

## Freezing the screen

You can temporarily freeze the screen by pressing the **Freeze** button  on the front control panel or the remote control. This is particularly useful when no other controls are available to pause a video, an animation, or other moving images.

When the image is frozen, a menu appears at the bottom of the screen featuring zoom, full screen, and close options. A magnifying glass icon also appears in the top-right corner of the screen.

### Note

Freezing the screen does not pause applications that are running on the connected computer. It simply freezes the displayed image.

To unfreeze the screen, press the **Freeze**  button again.

# Chapter 2 **Using apps on the display**

Using Whiteboard .....	29
Whiteboard tools and controls .....	29
Writing and erasing notes .....	31
Starting a new whiteboard .....	32
Changing the background .....	32
Navigating in the whiteboard .....	33
Opening an existing whiteboard .....	34
Saving a whiteboard .....	34
Importing or exporting a whiteboard .....	35
Exporting a whiteboard file to cloud storage .....	36
Email a whiteboard file .....	37
Changing whiteboard settings .....	37
Using Browser .....	37
Using Screen Share .....	38
Main Screen Share interface features .....	38
Main Screen Share interface .....	38
Connection code .....	39
Menu options .....	39
Device management .....	39
# connected devices .....	39
User guide .....	39
Floating menu (normal/mini) .....	39
Active Screen Share .....	40
Screen Share name and Bytello share website address .....	40
Annotation menu .....	40
Screen copy, Settings, About, and exiting the app .....	40
Screen copy .....	40
Settings .....	41
About .....	42
Exit .....	42
Screen share features available with each screen share method .....	42
Bytello Share App .....	42
AirPlay .....	43
Miracast .....	43
Chromecast .....	44
Webcast .....	45
Connecting a device to the display .....	45

Verifying the network .....	46
Connecting your device to the display .....	46
Managing connected devices .....	47
Minimizing and rearranging screens .....	49
Stopping a session .....	50
Using the Bytello Share app .....	51
Device requirements for using Bytello Share .....	51
Downloading and using the Bytello Share app .....	51
Using the Bytello Share app to interact with the display .....	53
Using Desktop Sync .....	54
Using Remote .....	55
Device Sync .....	55
Using native streaming (AirPlay, Miracast, or Chromecast) .....	56
Connect using Webcast .....	57
Using Palette .....	58
Palette tools and controls .....	58
Tools and controls for creating and sharing your palettes .....	58
Tools for painting, drawing, and erasing on the digital canvas .....	59
Starting a new palette .....	60
Changing the background .....	60
Writing and drawing on a palette .....	61
Exiting a palette .....	61
Using Camera .....	61
Viewing, annotating, and saving screen captureshots from a connected camera .....	62
Exiting Camera .....	65
Using Clean .....	65
Opening and closing the Clean app .....	65
Using the One Key Optimize tool .....	65
Using the Clean Memory tool .....	65
Using the Clean Trash tool .....	66
Using Cloud Drive .....	66
Using WPS Office .....	67
Opening the WPS Office app .....	67
Using the WPS Office app .....	67
Using File manager .....	67
Opening File manager .....	67
Viewing files .....	68
Moving or copying files .....	68
Using a USB drive .....	68
Using a Google Drive or OneDrive account .....	70
Installing apps using File Manager .....	71

Supported file formats .....	72
Using SMART Remote Management .....	72
Using Settings .....	72
Unsupported apps .....	72

This chapter introduces the apps on SMART Board GX (V2) series interactive displays.







## Using Whiteboard













You can view and erase notes, open a saved note, and save your notes to the display, a USB drive, or cloud account. You can also email a copy of your notes.

### Whiteboard tools and controls





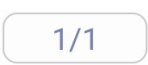

The Whiteboard app has a number of tools and controls for accessing and managing whiteboard sessions.









Tool	Icon	Description
<b>Menu tools</b>		
Tap the <b>Menu</b> icon  in the lower left corner to open the menu of tools for saving and sharing.		
New		Start a new whiteboard.
Open		Open a whiteboard saved on the display, from a USB drive, or a Google Drive or OneDrive account.
Save		Save a new whiteboard file to the display, to a USB drive, or a Google Drive or OneDrive account. Saves all pages into one whiteboard file in .enb format. Saving the current whiteboard file will replaces previously saved versions.
Save As		Rename the current whiteboard and save it without overwriting a previously saved version.
Import		Import a file from a USB drive or a Google Drive or OneDrive account onto the whiteboard page. Supported file formats are .img, .pdf, .svg, and .iwb.
Export		Export all the whiteboard pages into sequentially-numbered .png files or as a single .pdf file. Support file formats are .img, .pdf, .svg, and .iwb.

Tool	Icon	Description
Cloud Storage		Save the whiteboard contents directly to a Google Drive or OneDrive account. When you are signed in, the files upload in .png format directly to a date- and time-stamped folder.  <b>Note</b> To add a Google Drive or OneDrive account to the display, select the drive type when prompted and sign in.
Theme		Add templates, grids, preset lines, or a background image to the whiteboard, or change the background's color.
Send an Email		Email a copy of the current whiteboard session. (The email account must first be configured in display settings.) See the <i>SMART Board GX (V2) series interactive displays installation and maintenance guide</i> ( <a href="http://smarttech.com/kb/171861">smarttech.com/kb/171861</a> )
Settings		Access options for configuring the eraser mode, enabling multi-finger writing, enabling the display brightness to adjust automatically when writing, and customizing which tools appear in the toolbar.
<b>Other controls</b>		
Menu		Access a menu of tools for saving and sharing.
Exit		Exits the Whiteboard app.
List		Shows a list of whiteboard files created and saved. You can also create a new whiteboard session.
<b>Navigation tools</b>		
Add a page		Add a new page to the current whiteboard.
Next		Advance to the next page.
Previous		Return to the previous page.
Page number		Shows the current page number and enables you to go to a specific page or delete pages. Tap the box to expand and see all pages in the file.

## Writing and erasing notes

The Whiteboard has several tools for drawing and erasing.

Tool	Icon	Description
Select		<p>Select objects and manipulate them by moving, rotating, resizing, copying, or deleting them. Options are also available for adding color to an object, converting objects to text, to text, changing an object's orientation, arranging the order of objects, copying or deleting an object, and more.</p> <p>Select images to enable cropping, changing a picture's orientation, arranging the order of pictures, copying pictures, and deleting pictures, or converting to .svg file format.</p>
Pen		<p>Change ink color and choose from a variety of pen styles.</p> <p>Tap the Pen tool to select it, then tap again to change its color. You can select a different color and style for each end of the pen. You can use a pen or finger to write or draw on the whiteboard.</p> <p><b>Notes</b></p> <ul style="list-style-type: none"> <li>• Dual-pen writing is supported when multi-finger writing is enabled in settings (see <i>Settings</i> on the previous page), allowing users to write with different colors or pen styles at the same time in partition mode.</li> <li>• When the Pen tool is selected, a finger acts as the pen's thick nib.</li> </ul>
Eraser		<p>Use the Eraser tool to erase digital ink and objects on a whiteboard. You can use a pen or finger to erase ink.</p> <p>Tap on the Eraser to select it, then tap again to show the slider. Drag the slider to change the eraser size.</p> <p>From the Menu, tap <b>Settings</b> to change the eraser mode.</p>
Clear all		<p>Delete all the current whiteboard page's contents with one touch. Tap <b>Clean All</b> only when you are sure you want to clear the board: you won't be prompted to confirm this selection before the board is cleared. This feature also clears any objects you've added (except for rulers).</p>
Ruler		<p>Add a ruler or protractor to a whiteboard. Change the size and orientation of the tools as needed.</p>
Shape		<p>Add a range of two- and three-dimensional geometric shapes to a whiteboard. You can also fill and change the color of the shapes. Select the shape and the color, then press and hold as you draw the shape.</p>

Tool	Icon	Description
Table		Add tables to a whiteboard. Select the size and then insert the table. Draw within the table to change cell sizes.
Pair mode		Partition the screen into equal non-overlapping parts. Each participant has their own space for writing and drawing. You can have up to four partitions.
Mind map		Add a mind map to a whiteboard. Add text to a node and then drag it into position. Tap + to add more nodes. To delete a node, tap ... and tap <b>Delete</b> .
Sticky notes		Add a sticky note to a whiteboard. You can move notes around as needed. The Clear All feature deletes the notes.
Preview		Tap the <b>Preview</b> tool to select it, then tap again to display and inset an image of the total whiteboard. You can pan and zoom the inset image using finger gestures.
Grid		Add a grid to the whiteboard and convert handwriting to text. The handwritten font is also searchable. Tap the <b>Select</b> tool, tap the grid, and then tap <b>Search</b> .
Undo		Reverse the effect of the last action.
Redo		Reinstate the last action reversed with the Undo command.

### Starting a new whiteboard

On the display's Home screen, tap the **Whiteboard** icon .

OR

Tap **New** in an open whiteboard.



A new whiteboard appears.

### Changing the background

You can change the whiteboard's background. If a whiteboard has multiple pages, each page can have a different background. When you export or share the whiteboard, the background you've selected also appears.



### To change the whiteboard's background

1. Tap the **Menu** icon .
2. Tap the **Theme** icon .
3. Tap **Template** and select a background from the templates provided.

OR

Tap **Background** and change the whiteboard's background color, or upload an image to the background.

The background appears.

#### Notes

- The whiteboard will save the image background for later use. Delete unused images by tapping the Trash icon in the corner of the image.
- When adding a new page, the background theme of the current page applies to the new page.

### Navigating in the whiteboard

Tap the **Preview** tool icon  to select it, then tap again to see the complete whiteboard.

Use two fingers to pinch to zoom in.

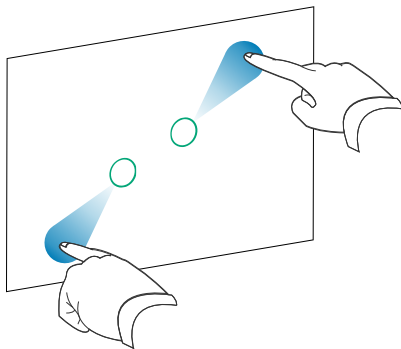

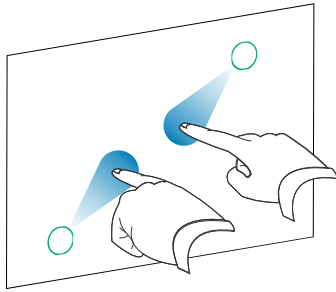

Use two fingers to pinch to zoom out.



## Opening an existing whiteboard

You can easily continue from where you left off in a saved whiteboard.

1. Tap the **Whiteboard** icon .
2. Tap the **Menu** icon .
3. Tap the **Open** icon .

The *Storage* dialog appears.

4. Browse to and tap the whiteboard you want to open.

You can open a file from the display, a USB drive, or a Google Drive or OneDrive account.

5. Tap **OK**.

## Saving a whiteboard

You can save a whiteboard.

### To save a new whiteboard

1. Tap the **Save** icon .

The *Storage* dialog appears.

2. Browse to where you want to save the new file.

#### Notes

- You can save a file to the display, a USB drive, or to a Google Drive or OneDrive account.
- The Whiteboard pages are saved as an .enb file. To convert the file into a different format, tap **Export**.

The *Save all pages* dialog appears.

3. Type a name for the file in the File name box.
4. Tap **OK**.

### To save an existing whiteboard

Tap the **Save** icon .

### To save an existing whiteboard with a new name or location

1. Tap the **Save As** icon .

The *Storage* dialog appears.

2. Browse to where you want to save the new file.

#### Notes

- You can save a file to the display, a USB drive, or to a Google Drive or OneDrive account.
- The Whiteboard pages are saved as an .enb file. To convert the file into a different format, tap **Export**.



The *Save all pages* dialog appears.

3. Type a name for the file in the **File name** box.
4. Tap **OK**.

## Importing or exporting a whiteboard

You can import or export a whiteboard.

### To import a whiteboard

1. Tap the **Menu** icon .
2. Tap the **Import** icon .
3. Select the file type you want to import (supported formats are img, .pdf, .svg, and .iwb).
4. Browse to and select the file.



You can open a file from the display, a USB drive, or from a Google Drive or OneDrive account.

5. Tap **OK**

#### Note

The imported file is added to the existing whiteboard file as an image.

### To export a whiteboard

1. Tap the **Menu** icon .
2. Tap the **Export** icon .
3. Select the file type for the export (supported formats are .img, .pdf, .svg, and .iwb).
4. Browse to where you want to save the file.



You can save a file to the display, a USB drive, or to a Google Drive or OneDrive account.

#### Note

You can rename a file by tapping the name and using the on-screen keyboard.

5. Tap **OK**.

### Exporting a whiteboard file to cloud storage

1. Tap the **Menu** icon .
2. Tap the **Cloud Storage** icon .
3. If this is the first time uploading a file to a cloud account from the display, you're prompted to sign in to a Google Drive or OneDrive account.

OR

Select an account in the *Upload to* box. You can rename a file by tapping the name and using the on-screen keyboard.

#### Note

- If you're already signed in to a cloud account and have selected a folder destination, the file is uploaded automatically.
- The pages are uploaded as sequentially numbered .png files into a time-stamped folder.
- To change the file format, tap **Export** and select **Cloud Drive**.
- You can manage your cloud accounts using the display's **Cloud Drive**  app (see *Using Cloud Drive* on page 66).



4. Tap **OK**

## Email a whiteboard file

### Note

To enable this feature, you must first add an email account to the display in Settings.

For more information, see *SMART Board GX (V2) series interactive displays installation and maintenance guide* ([smarttech.com/kb/171861](http://smarttech.com/kb/171861)).

1. Tap the **Menu** icon .
2. Tap the **Send Email** icon .

## Changing whiteboard settings

In whiteboard settings, you can change the eraser mode, enable multi-finger writing or automatic brightness, customize the toolbar, and more.

### To change a whiteboard setting

1. Tap the **Menu** icon .
2. Tap the **Settings** icon  and browse to the setting you want to change.

## Using Browser



The display includes a web browser that you can use as you would on your computer or mobile device. Refer to the Help in the browser.

### Tip

Tap the + icon in the top-right corner to open a new web browser tab.

### Notes

- The browser doesn't support the installation of plug-ins and add-ons.
- Writing or drawing in digital ink is not optimized for use in Lumio by SMART within the display's browser. You might want to use the split screen widget to simultaneously create notes in a Whiteboard file while viewing Lumio in the browser.

See *Using the Split screen widget* on page 87.

# Using Screen Share



You can wirelessly share images, videos, or your computer or mobile device’s desktop to the display.

## Notes

- Bytello Share is a third-party application. SMART’s support for this application may vary depending on the inquiry.
- For the best performance, use the Bytello Share app to connect.
- Make sure your computer or mobile device is connected to the same network as the display.
- Some Bytello features are not available on some mobile devices or computers (see *Device requirements for using Bytello Share* on page 51).

## Main Screen Share interface features

The main Screen Share interface features a number of menus and controls.

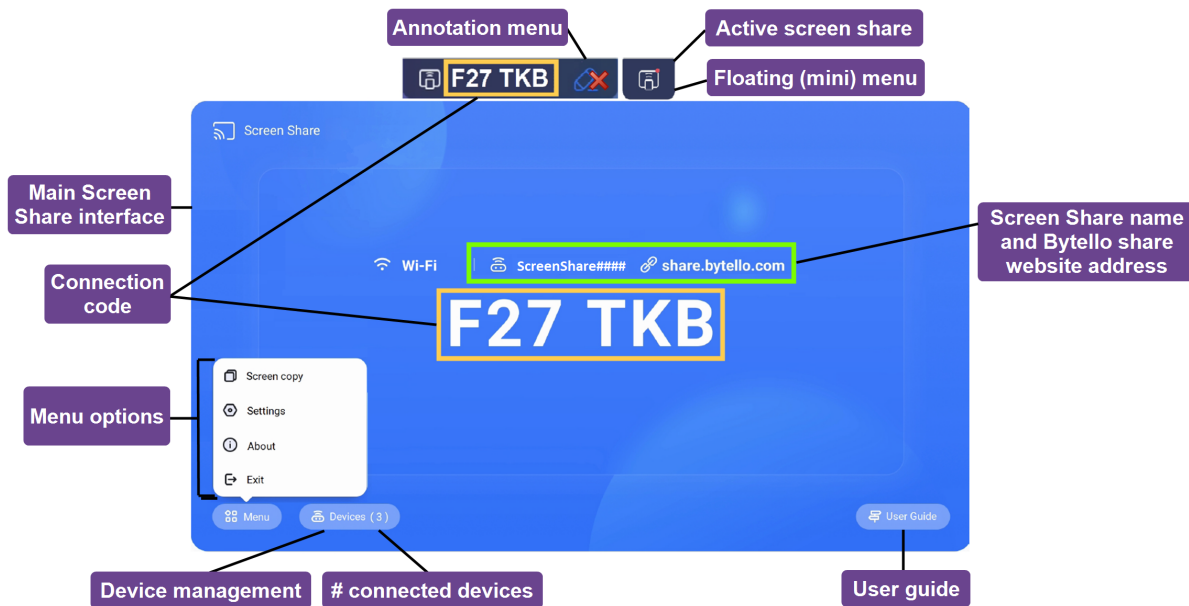

### Main Screen Share interface

This is the main screen for the Screen Share app. You can see whether the display is using a Wi-Fi or Ethernet network connection (tap the connection status to see the display’s network settings), the screen share name, and connection code.

### **Connection code**

Both the Bytello Share app and the Bytello Share website require a 6-digit connection code for connecting to the display. Depending on the Screen Share app's settings, the code changes at a regular interval for security purposes. Always use the current code to connect to the display (see *Settings* on page 41).

You'll find the connection code on the Screen Share app's main interface or in the floating menu at the top of the display (if it's set to Normal size).

### **Menu options**

See *Screen copy, Settings, About, and exiting the app* on the next page.

### **Device management**

Device Management lists the connected devices, their status, device permissions, and options (see *Device management* above).

### **# connected devices**

Shows the number of devices that are currently connected.

### **User guide**

The Screen Share app has a built-in user guide that can help you connect or troubleshoot at the display.

### **Floating menu (normal/mini)**

The floating menu appears at the top of the display when the Screen share app is running. Tap the menu to expand it and see a variety of information:

- the network name
- the Screen Share name for AirPlay, ChromeCast, and Miracast connections, if enabled in settings (see *Settings* on page 41).
- the 6-digit connection code
- access to the main interface

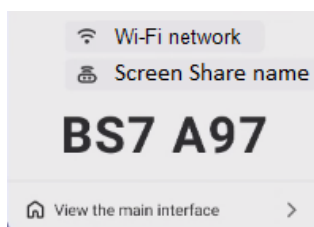

### Tip

You can change the floating menu's size or disable it in the Screen share app's settings (see *Menu options* on the previous page).

### Active Screen Share

The orange dot appears on the floating menu to indicate that a screen sharing session is active and devices are connected to the display.

### Screen Share name and Bytello share website address

This Screen Share name identifies the current screenshare session (for use when connecting via AirPlay, Chromecast, or Miracast) and the website address participants can use to connect via the Bytello Share website. Participants can use the website to connect without downloading and installing apps or software. The address appears on the screen only when screen share via website is enabled in the Screen Share app's settings (see *Settings* on the next page).

### Annotation menu

An annotation toolbar is available when using the Desktop Sync option in the Bytello Share app. Tapping this floating toolbar allows users to access tools for drawing over the display on an overlay, erasing ink, taking screen captures, sharing files, and more.

If connected devices have touchback permissions enabled, it's also possible for those users on shared devices to access this menu.

For more information, see *To annotate* on page 55.

## Screen copy, Settings, About, and exiting the app

Access the Screen Share app's menu options to use Screen copy, customize the app's settings, or update the app. Expand the sections below to learn more about each option.

### Screen copy

#### For displays only



The Screen copy  feature enables a SMART Board GX (V2) display's screen to be mirrored on other SMART Board GX (V2) display screens. Access this feature from the Menu on the Screen Share app's main interface (see *Menu options* on the previous page).

#### *Screen Share*

Tap **Start sharing** to share your display's screen to other displays.

#### *Join sharing*



Tap **Join now** to mirror another display's screen on your display.

### Settings

Access **Settings**  from the Menu on the Screen Share app's main interface. Change the display name and set your permissions, mirroring, and general preferences.

#### To customize settings

Tap  to turn a setting on or off.

OR

Tap the arrow  to open a drop-down menu and change the setting.

Setting	Description
<i>Allow this device to be discovered</i>	Allows the Bytello Share app to discovered this display via the <i>ScreenShare</i> name.
<i>Permission mode</i>	When enabled, <i>Screenshare requires permission</i> shows when participants are requesting to cast to the display and requires approval.
<i>Support Chromecast device</i>	Makes the server discoverable for Chromecast-supported devices, including connecting via <b>Cast...</b> through the Chrome browser.
<i>Support Airplay device</i>	Makes the server discoverable for AirPlay-supported devices.
<i>Support Miracast device</i>	Makes the server discoverable for Miracast-supported devices.  <b>Note</b> This feature is turned off by default to reduce network congestion.
<i>Share screen via website</i>	Allows devices to connect to Screen Share via the Bytello Share website. Enter the URL <a href="https://share.bytello.com">https://share.bytello.com</a> in the address bar of your computer's browser.
<i>Device name</i>	Change the <i>ScreenShare</i> name of the display by tapping  . Type a custom name using the on-screen keyboard.
<i>Start automatically on boot</i>	When enabled, the Screen Share application will run when the system starts. The floating menu shows at the top of the display to show that the app is running.
<i>Code refresh rate</i>	Sets the interval at which a new connection code is generated.

Setting	Description
<i>Floating window size</i>	You can change the size of the floating window at the top of the display. <ul style="list-style-type: none"> <li>• <i>Normal</i> shows the connection code with icon</li> <li>• <i>Small</i> shows only the icon of the floating window</li> <li>• <i>Minimize</i> disables the floating window</li> </ul>
<i>Product User Experience Plan</i>	Choose whether to send operational behavior data from the Screen Share app to the app's developer. The data is then used by the developer to help improve the Screen Share app's user experience.
<i>Log Feedback</i>	If you encounter an issue while using the Screen Share app, you can use the <i>Log Feedback</i> feature to send the Screen Share app's developer the app's log file to aid with troubleshooting.

### About

① About contains information about the software version and legal agreements

When there is a new version, click or tap **Update** to upgrade.

### Exit

⌵ Exit the Screen Share app.

## Screen share features available with each screen share method

Some features of the display's Screen Share app are available only when using certain screen share methods. Expand the sections below to see a summary of what's available for each method.

### Bytello Share App

Feature	Windows	MacOS	iOS	Android	Chrome OS
Screen sharing	<input checked="" type="checkbox"/>	<input checked="" type="checkbox"/>	<input checked="" type="checkbox"/>	<input checked="" type="checkbox"/>	<input checked="" type="checkbox"/>
Touchback	<input checked="" type="checkbox"/>	<input checked="" type="checkbox"/>	<input type="checkbox"/>	<input type="checkbox"/>	<input type="checkbox"/>
Audio sharing	<input checked="" type="checkbox"/>	<input checked="" type="checkbox"/>	<input checked="" type="checkbox"/>	<input checked="" type="checkbox"/>	<input type="checkbox"/>
Desktop Sync	<input checked="" type="checkbox"/>	<input checked="" type="checkbox"/>	<input checked="" type="checkbox"/>	<input checked="" type="checkbox"/>	<input checked="" type="checkbox"/>
Device Sync	<input checked="" type="checkbox"/>	<input checked="" type="checkbox"/>	<input type="checkbox"/>	<input type="checkbox"/>	<input type="checkbox"/>
Annotation	<input checked="" type="checkbox"/>	<input checked="" type="checkbox"/>	<input checked="" type="checkbox"/>	<input checked="" type="checkbox"/>	<input checked="" type="checkbox"/>
Camera sharing	<input type="checkbox"/>	<input type="checkbox"/>	<input checked="" type="checkbox"/>	<input checked="" type="checkbox"/>	<input checked="" type="checkbox"/>
Document sharing	<input type="checkbox"/>	<input type="checkbox"/>	<input type="checkbox"/>	<input checked="" type="checkbox"/>	<input checked="" type="checkbox"/>

Feature	Windows	MacOS	iOS	Android	Chrome OS
Photo sharing	<input type="checkbox"/>	<input type="checkbox"/>	<input checked="" type="checkbox"/>	<input checked="" type="checkbox"/>	<input checked="" type="checkbox"/>
Video/Audio sharing	<input type="checkbox"/>	<input type="checkbox"/>	<input checked="" type="checkbox"/>	<input checked="" type="checkbox"/>	<input checked="" type="checkbox"/>
Remote control	<input type="checkbox"/>	<input type="checkbox"/>	<input checked="" type="checkbox"/>	<input checked="" type="checkbox"/>	<input checked="" type="checkbox"/>
Pause screen sharing	<input checked="" type="checkbox"/>	<input checked="" type="checkbox"/>	<input type="checkbox"/>	<input type="checkbox"/>	<input type="checkbox"/>
No app install required	<input type="checkbox"/>	<input type="checkbox"/>	<input type="checkbox"/>	<input type="checkbox"/>	<input type="checkbox"/>

**AirPlay**

Feature	MacOS	iOS
Screen sharing	<input checked="" type="checkbox"/>	<input checked="" type="checkbox"/>
Touchback	<input type="checkbox"/>	<input type="checkbox"/>
Audio sharing	<input checked="" type="checkbox"/>	<input checked="" type="checkbox"/>
Desktop Sync	<input type="checkbox"/>	<input type="checkbox"/>
Device Sync	<input type="checkbox"/>	<input type="checkbox"/>
Annotation	<input type="checkbox"/>	<input type="checkbox"/>
Camera sharing	<input type="checkbox"/>	<input type="checkbox"/>
Document sharing	<input type="checkbox"/>	<input type="checkbox"/>
Photo sharing	<input type="checkbox"/>	<input type="checkbox"/>
Video/Audio sharing	<input type="checkbox"/>	<input type="checkbox"/>
Remote control	<input type="checkbox"/>	<input type="checkbox"/>
Pause screen sharing	<input type="checkbox"/>	<input type="checkbox"/>
No app install required	<input checked="" type="checkbox"/>	<input checked="" type="checkbox"/>

**Miracast**

Feature	Android	Windows
Screen sharing	<input checked="" type="checkbox"/>	<input checked="" type="checkbox"/>
Touchback	<input checked="" type="checkbox"/>	<input checked="" type="checkbox"/>
Audio sharing	<input checked="" type="checkbox"/>	<input checked="" type="checkbox"/>

Feature	Android	Windows
Desktop Sync	<input type="checkbox"/>	<input type="checkbox"/>
Device Sync	<input type="checkbox"/>	<input type="checkbox"/>
Annotation	<input type="checkbox"/>	<input type="checkbox"/>
Camera sharing	<input type="checkbox"/>	<input type="checkbox"/>
Document sharing	<input type="checkbox"/>	<input type="checkbox"/>
Photo sharing	<input type="checkbox"/>	<input type="checkbox"/>
Video/Audio sharing	<input type="checkbox"/>	<input type="checkbox"/>
Remote control	<input type="checkbox"/>	<input type="checkbox"/>
Pause screen sharing	<input type="checkbox"/>	<input type="checkbox"/>
No app install required	<input checked="" type="checkbox"/>	<input checked="" type="checkbox"/>

### Chromecast

Feature	PC only (Win/Mac/Chrome)
Screen sharing	<input checked="" type="checkbox"/>
Touchback	<input type="checkbox"/>
Audio sharing	<input checked="" type="checkbox"/> <sup>1</sup>
Desktop Sync	<input type="checkbox"/>
Device Sync	<input type="checkbox"/>
Annotation	<input type="checkbox"/>
Camera sharing	<input type="checkbox"/>
Document sharing	<input type="checkbox"/>
Photo sharing	<input type="checkbox"/>
Video/Audio sharing	<input type="checkbox"/>
Remote control	<input type="checkbox"/>
Pause screen sharing	<input type="checkbox"/>
No app install required	<input checked="" type="checkbox"/>

<sup>1</sup>Audio is shared automatically with the display. The mute button is only available on Windows and ChromeOS devices when sharing your entire screen.

**Webcast**

Feature	Windows	MacOS	Chrome OS
Screen sharing	<input checked="" type="checkbox"/>	<input checked="" type="checkbox"/>	<input checked="" type="checkbox"/>
Touchback	<input type="checkbox"/>	<input type="checkbox"/>	<input type="checkbox"/>
Audio sharing	<input checked="" type="checkbox"/> <sup>2</sup>	<input checked="" type="checkbox"/> <sup>3</sup>	<input checked="" type="checkbox"/> <sup>4</sup>
Desktop Sync	<input type="checkbox"/>	<input type="checkbox"/>	<input type="checkbox"/>
Device Sync	<input type="checkbox"/>	<input type="checkbox"/>	<input type="checkbox"/>
Annotation	<input type="checkbox"/>	<input type="checkbox"/>	<input type="checkbox"/>
Camera sharing	<input type="checkbox"/>	<input type="checkbox"/>	<input type="checkbox"/>
Document sharing	<input type="checkbox"/>	<input type="checkbox"/>	<input type="checkbox"/>
Photo sharing	<input type="checkbox"/>	<input type="checkbox"/>	<input type="checkbox"/>
Video/Audio sharing	<input type="checkbox"/>	<input type="checkbox"/>	<input type="checkbox"/>
Remote control	<input type="checkbox"/>	<input type="checkbox"/>	<input type="checkbox"/>
Pause screen sharing	<input type="checkbox"/>	<input type="checkbox"/>	<input type="checkbox"/>
No app install required	<input checked="" type="checkbox"/>	<input checked="" type="checkbox"/>	<input checked="" type="checkbox"/>

**Connecting a device to the display**

The Screen Share app on GX (V2) displays enables you to share a computer or mobile device's screen to the display.

The display's Screen Share app supports devices configured with the Bytello Share App and native streaming from devices (Airplay, Miracast, and Chromecast). Regardless of the method you choose for sharing a device's screen, the steps for starting and managing a screen share session are the same:

- Verify the network
- Connect devices to the display
- Manage connected devices
- Minimize and rearrange screens
- Stopping a screen share session

<sup>2</sup>Audio sharing is not available when sharing a window.

<sup>3</sup>Audio sharing is only available when sharing a tab.

<sup>4</sup>Audio sharing is not available when sharing a window.

Expand the sections below to learn more about each step.

### **Verifying the network**

Your device must be on the same network as the display to connect using the Bytello Share App or native streaming from devices (Airplay, Miracast, and Chromecast). Use the following procedure to verify that your device and the display are connected to the same network.

1. From the display's Home screen, tap **Screen Share** .

The main Screen Share interface opens.

OR

Tap the floating menu icon  at the top of the Home screen of the display if Screen Share is running.

2. Make a note of the network the display is connected to. The name appears beside the  icon.
3. Verify that your device is connected to the same network. Consult your device's user guide for more information.

### **Connecting your device to the display**

1. From the display's Home screen, tap **Screen Share** .

The main Screen Share interface opens.

2. Verify that your device and display are connected to the same Wi-Fi network (see *Verifying the network* above).

#### **Notes**

- If you're using the Bytello Share app, make a note of the 6-digit connection code.
- If you're using a method other than the Bytello Share app (such as AirPlay, Chromecast, or Miracast), make a note of the *ScreenShare* name next to the  icon.

3. Choose from one of these connection methods listed below.
  - Bytello Share app (see *Using the Bytello Share app* on page 51).

**Tip**

For the best performance, use the Bytello Share app to connect.

- Native streaming services
  - Airplay (available on iOS and Mac devices). See *To use AirPlay* on page 56.
  - Miracast (available on Android and Windows devices). See *To use Miracast* on page 56.
  - Chromecast (available on Chrome OS, Mac, and Windows computers). See *To use Chromecast to connect from a Chrome browser or Chromebook* on page 57.
  - Webcast (with a URL). See *Connect using Webcast* on page 57.
- 4. Wait for the device to automatically connect or for the host to accept your request to join.
- 5. Pause or exit the screen share at any time.

**Managing connected devices**

View all connected device, their status, available device permissions, and options.



**To manage devices**











1. On the display’s Home screen, tap **Screen Share** .

OR

Tap the floating menu at the top of the display, then tap **View main screen**. The main screen opens.

2. Tap  in the bottom left-corner to open the devices list. You can see which devices are connected and how they are sharing to the display. Tap the blue and red icons on the display to assign or change permissions and connections.

Tool	Icon	Description
Airplay		Device is connected via AirPlay.
Miracast		Device is connected via Miracast.
Mobile connection via app		Mobile device is connected via Bytello Share app.

Tool	Icon	Description
Computer connection via app		Computer is connected via Bytello Share app.
Computer connection via Cast		Computer is connected via Cast from the Chrome browser.
Computer connection via URL		Device is connected via Bytello Share URL/website
Invite to share		Invite connected devices to cast their desktop from the display. This happens automatically for a PC.
Touchback permissions		<p>Give touchback permissions to a connected device in Desktop sync mode.</p> <p>Giving touchback permission will allow the user to control the display from their device. This includes opening and closing apps, controlling screen sharing capabilities, and making annotations on the display (see <i>To annotate</i> on page 55).</p> <p><b>Note</b></p> <p>This option does not allow touch control of other devices connected to the display.</p> <p>For mobile devices, also see Remote control (see <i>Using Remote</i> on page 55).</p>
File sharing		Send files from the display to any connected device.
Admin authorization		Set a device as an administrator to accept or reject further sharing requests.
Preview device screen <sup>5</sup>		Preview a connected device's screen before a user shares it.
Stop sharing		Stops devices from sharing their screen. Devices remain connected.
Disconnect		Disconnects devices from the display. You can disconnect individually, or tap the top-most Disconnect icon to disconnect all devices.

<sup>5</sup>Previewing a connected device's screen is available only with Mac, Windows, Android, and ChromeOS devices.



### Minimizing and rearranging screens

It's possible to share up to nine screens on the display depending on the method used to share devices. You can connect using a combination of methods as well.

Mirroring method	Maximum number of devices
Bytello Share app	9
AirPlay	9
Miracast	2
Chromecast/Chrome browser	1
Webcast	2



When devices are sharing their screens to the display, you can access a tool bar of controls for each shared screen. The controls available include ending a screen sharing session, minimizing a screen, and controlling the volume of a shared screen.



#### To access the shared screen tool bar

1. Tap anywhere on the display's screen. The toolbar appears in the bottom left corner of each shared screen.
2. Tap a toolbar icon in the toolbar to perform one of the actions in the table below:

#### Note

The availability of each tool bar control depends on the connection method and the connected device's type.

Tool	Icon	Description
End		End the current screen sharing session.
Minimize		Minimize the screen sharing session to access other areas of the display's screen. You can also press the display's Home button.  <b>Note</b> You can view the screen sharing session at any time by tapping the floating toolbar on the top of the display's screen, then tapping <b>View the screen share</b>
Floating window mode		View the shared screen in a floating window. You can move a window on the display by tapping and dragging the window. Touchback is not supported in floating windows.

Tool	Icon	Description
Volume		Mute or unmute the shared audio. Some devices don't support audio, so this button might not always appear. See <a href="#">Features</a> .
Screen view		Switch between screen views. The blue icon in the corner shows how many screens are currently sharing their screen to the display.

When multiple devices are sharing screens to the display, you can move them.

### To rearrange screens

1. On the display, press and hold the screen that is sharing, then drag the window to adjust the order.

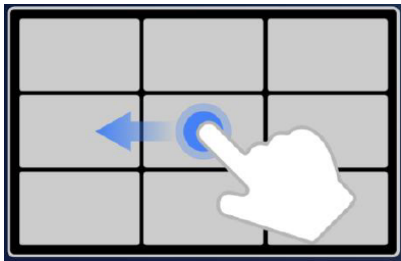

2. Release to change positions.

### Stopping a session

Participants can stop sharing their screen by tapping . The host can also disconnect a participant.

### To disconnect a device as a participant

The process for disconnecting a device as a participant varies depending on your device and the connection method. Consult your device's user guide for more information.

### To disconnect a participant as the host

#### Tip

You can disconnect all devices by tapping  at the top of the list.

1. Tap **Devices**  on the Screen Share app's main screen.

The Device management screen opens (see *Managing connected devices* on page 47).

2. Choose a device from the list and tap  to disconnect it.
3. Tap **Disconnect** to confirm.

## Using the Bytello Share app

For the best performance, use the Bytello share app to connect your device to the display.

### Device requirements for using Bytello Share

Device	Requirement
iOS devices (iPhone 6 or later)	iOS 10.0 and later
Android devices	Android 5.0 and later (Android 10.0 recommended)
Windows computers	Windows 7, 8, 10 and later
Mac computers	Mac OS X 10.11, 11 and later
Chrome browser	Chrome 38 and later
Linux	Ubuntu 12.04 and later

### Downloading and using the Bytello Share app

You can use the Bytello Share app to mirror your device, sync with the display, share files, and more. Begin by downloading and installing the app on your device. For device requirements, see *Device requirements for using Bytello Share* above.

#### Note

After you install the Bytello Share app, the Bytello camera view may become the default camera in collaboration software installed on your device. You can use your collaboration software's settings to select the camera you want to use.

### To download the Bytello Share app

- From the display's Home screen, tap **Screen Share** .
 

The main Screen Share interface opens.
  - Tap the **User Guide** icon .
  - In your device's browser, enter the URL specified on the display's screen in the *Install* section (<https://ssp.bytello.com/download>).
- OR
- Use a QR code scanning app on your device to scan the QR code on the display's screen.
- Download and install the Bytello Share app for your device.

### **To connect your device to the display**

1. Verify that your device and display are connected to the same Wi-Fi network (see *Verifying the network* on page 46).
2. Open the Bytello Share app on your computer or mobile device.
3. Enter the 6-digit connection code shown on the Screen Share app's main interface or in the floating menu at the top of the display.

OR

Click or tap the *ScreenShare* name (see *Screen Share name and Bytello share website address* on page 40) of the display you want to connect to in the *Searching for connectable devices* section.

4. Wait for the device to automatically connect or for the host to accept your request to join.

The features available after connection depend on the device you are using. See the table below.

### **To share your device's screen to the display**

1. Open the Bytello Share app on your device and connect to the display.
2. Wait for the device to automatically connect or for the host to accept your request to join.

- The app provides the following options to share your screen (options will depend on the device you are using):

Option	Description	Devices
Screen Share	<p>Share your device’s screen to the display using one of the options listed (Desktop, Window, extend screen, and so on).</p> <p><b>Note</b></p> <p>If Permission Mode is enabled, the host at the display will have to accept your request to join. Otherwise, your device will share its screen automatically.</p> <p><b>Tip</b></p> <p>If you’d like to disable Touchback at the display, use the menu at the top of your computer screen to change permissions.</p>	All
Media	Share a video from your mobile device to the display. In the app, tap <b>Media</b> and select the video to share.	Mobile
Photo	Share a photo from your mobile device to the display. In the app, tap <b>Photo</b> and select the image to share.	Mobile
Document	Share a document from your mobile device to the display. In the app, tap <b>Document</b> and select the file to share.	Mobile
Camera	Share a live view from your mobile device’s camera to the display. In the app tap <b>Camera</b> , then <b>Record</b> .	Mobile
Remote	Your mobile device behaves as a large touchpad, with a left-click and back button, to control a pointer on the display.	Mobile

- When you’re done sharing, click or tap **Close**  in the *Screen share* menu on your device.
- Tap  to disconnect.

**Using the Bytello Share app to interact with the display**

You can interact with the display using the Bytello Share app on your device, including controlling whether Touchback permissions are enabled (see *Managing connected devices* on page 47). Select whether you want to use the remote control feature or duplicate the display’s screen to your device.

Option	Description	Devices
Desktop Sync	Mirror the display's screen on your device. If Touch permissions are enabled for your device (see <i>Managing connected devices</i> on page 47), you can control the display and open and close files, manage apps, and annotate on the display's screen. Annotations can be saved to the display or shared to devices connected with the Bytello Share app (see <i>To annotate</i> on the next page).	All
Remote	Your mobile device behaves as a large touchpad, with a left-click and back button, to control a pointer on the display.	Mobile
Device Sync	Sync your device to the display's externally connected camera or microphone, creating a virtual camera and microphone. Use this feature for meetings in third-party conference software.	PC

### Using Desktop Sync

When you use the Desktop Sync feature, the display's screen appears on your device. If Touchback permissions are enabled for your device, you can control the display and open and close files, manage apps, and use a pen to draw on the display's screen.

#### Note

The Desktop Sync feature's performance can vary depending on the number of devices connected. Image quality can be affected if more than two devices are connected to the display and using this feature at the same time.

### To use Desktop Sync

1. Open the Bytello Share app on your device and connect to the display.
2. On your device, tap **Desktop Sync**.

#### Note







- For security purposes, touchback is automatically disabled, but you can enable it from the *Device management* page of the display's Screen Share app (see *Managing connected devices* on page 47).
- Touchback is available only on the maximized screen/docked screen.

3. Wait for your host to accept the request to sync your device's desktop to the display. The display's screen appears on your device.

In **Desktop Sync** mode, users can write on the display at the display itself and from the connected devices (if permissions are enabled). You can take a screen capture of the annotations and share the file with devices connected with the Bytello Share app.

**To annotate**

1. Make sure your device is in **Desktop Sync** mode.
2. From the floating menu on the display, tap the  icon to open the annotation toolbar.

Tool	Icon	Description
Pen		Touch behaves like a pen, drawing digital ink on the screen overlay. Tap the pen icon to change color. Use the pen feature to annotate over the screen sharing session. Devices with Touchback permissions enabled can also make annotations.
Erase		Touch behaves like an eraser, erasing digital ink drawn on the screen overlay.
Clean		Clears all of the annotations.
Save		Save the current screen to an image file on the display.
Insert		Insert an annotated screen capture into a whiteboard file on the display.
Share		Share annotations with devices that are connected with the Bytello Share app in Desktop Sync mode. Tap <b>Share</b> , select the device, and tap <b>Confirm</b> . The display sends a screen capture in .png format.

**Using Remote**

**For mobile devices only.**



1. Open the Bytello Share app on your device.
2. Connect to the display using the app.
3. On your device, tap **Remote** in the app.
4. Control the display using the touchscreen on your mobile device.

**Tip**

Tap the More  menu to switch between *Motion mode* and *Touchpad mode*.

**Device Sync**

**For PC only.**



The Device Sync feature enables you to connect your computer to a camera and microphone connected (optionally) to the display, creating a virtual camera and microphone. Use this feature for meetings in third-party conference software.

1. Open the Bytello Share app on your device and connect to the display.
2. In the app, click **Device Sync**.
3. Select whether to connect to the camera and microphone.

If a camera is connected to the display, you can see its view on your device's screen. If you sync the microphone, you can hear the audio in the room with the display.

## Using native streaming (AirPlay, Miracast, or Chromecast)

On networks that are configured to support AirPlay, Miracast, or Chromecast, participants can use native screen sharing without installing software or worrying about admin rights.

Streaming via AirPlay and Chromecast are enabled by default, but streaming via Miracast must be enabled in *Settings* (see *Settings* on page 41).

### To use AirPlay

1. From the display's Home screen, tap **Screen Share** .

The main Screen Share interface opens.

#### Note

Make a note of the *ScreenShare* name next to the  icon.

2. Verify that your device and display are connected to the same Wi-Fi network (see *Verifying the network* on page 46).
3. Follow the instructions for your device to use Airplay (see [Apple support](#)).

#### Note

Ensure that your Firewall settings are not blocking the Screen Share, Airplay, or the Apple Bonjour service from connecting. Refer to your device's user manual for more information.

### To use Miracast

#### Note

The steps to connect from an Android device vary depending on the device. The most common ways are using Smart view, Screen mirroring, and Quick Connect. Consult your Android device's user guide for details.



1. From the display's Home screen, tap **Screen Share** .

The main Screen Share interface opens.

**Note**

Make a note of the *ScreenShare* name next to the  icon.

2. Verify that your device and display are connected to the same Wi-Fi network (see *Verifying the network* on page 46).
3. Follow the instructions for your device to use Miracast, (see [Microsoft support](#) or your Android device's user guide).

### To use Chromecast to connect from a Chrome browser or Chromebook

1. From the display's Home screen, tap **Screen Share** .

The main Screen Share interface opens.

**Note**

Make a note of the *ScreenShare* name next to the  icon.

2. Verify that your device and display are connected to the same Wi-Fi network (see *Verifying the network* on page 46).
3. Follow the instructions for your computer to use Chromecast (see [Chrome support](#)).

**Note**

With this connection method, other devices can end the screen sharing session without warning.

### Connect using Webcast

Participants can connect via the Bytello Share website without downloading and installing apps or software. Make sure the Screen Share app is configured to allow Miracast connections (see [settings](#)).

1. From the display's Home screen, tap **Screen Share** .

The main Screen Share interface opens.

OR

Tap the floating menu  icon at the top of the Home screen of the display if Screen Share is running.

2. Verify that your device and display are connected to the same Wi-Fi network (see *Verifying the network* on page 46).
3. On your device, open your preferred browser and enter the URL [share.bytello.com](http://share.bytello.com).

4. Enter the 6-digit connection code shown on the Screen Share app's main interface or in the floating menu at the top of the display.

OR

Tap the display's name you want to connect to in the *Select a device* section.

5. Wait for the device to automatically connect or for the host to accept your request to join.

You can pause the screen share at any time.

6. When you're finished sharing, click the  icon or close or refresh the tab.

## Using Palette











The Palette app lets you paint or draw on a digital canvas using a variety of tools from a toolbox, colors from a color box, and a color mixing palette.

### Palette tools and controls

#### Tools and controls for creating and sharing your palettes







The Palette app has several tools and controls for creating and sharing your palettes.





Tool	Icon	Description
<b>Menu tools</b>		
Tap the <b>Menu</b> icon  in the lower left corner to open the menu of tools for saving and sharing.		
Save		Save the image as a .png file.
Import		Import a .png, .jpg, or .bmp image file onto the digital canvas. The image will be stretched to fill the background of the canvas.
Exit		Exit the Palette app.
<b>Other controls</b>		
Clear		Clear all digital ink.
Undo		Reverse the effect of the last action.

Tool	Icon	Description
Redo		Reinstate the last action reversed with the Undo command.
Sample		Sample a color from the image on the screen.
Fill		Fill a bounded area with the currently selected color.



### Tools for painting, drawing, and erasing on the digital canvas

The Palette app has several tools for painting, drawing, and erasing on the digital canvas. Tools in the toolbox support multitouch painting and drawing.



Tool	Purpose	Description
<b>Toolbox</b>		
 Pencil	Write or draw digital ink in the style of a pencil.	The pencil can be used for most writing applications.
 Pen	Write or draw digital ink in the style of a pen.	The pen is useful for teaching students handwriting.
 Crayon	Write or draw digital ink in the style of a wax crayon.	The crayon works best with artistic work, such as painting and coloring pictures, rather than writing.
 Paintbrush 1	Write or draw digital ink in the style of a narrow paintbrush.	The narrow paintbrush works best with artistic work, such as painting and coloring pictures, rather than writing.
 Paintbrush 2	Write or draw digital ink in the style of a wider paintbrush.	The wider paintbrush works best with artistic work, such as painting and coloring pictures, rather than writing.
 Charcoal pencil	Write or draw digital ink in the style of charcoal pencil.	The charcoal pencil works best with artistic work, such as painting and coloring pictures, rather than writing.

Tool	Purpose	Description
 Air brush	Write or draw digital ink in the style of an airbrush.	The air brush works best with artistic work, such as painting and coloring pictures, rather than writing.
 Eraser	Use a pen or finger as an eraser	Erase ink from the screen as needed. Multitouch is not supported.
<b>Palette</b>		
	Customize an existing color.	Use the palette tool to create a new color by customizing a color from the ColorBox. Select a color to be blended with the currently selected color, then slowly mix the palette until you achieve the desired color blend.
<b>ColorBox</b>		
 ColorBox	Select a color to use when you paint or draw on the digital canvas.	Choose a range of colors to draw or paint with. You can also mix and customize colors in the Palette tool.

## Starting a new palette

1. On the display's Home screen, tap the **Apps** icon .  
The Apps menu appears.
2. Tap the **Palette** icon .  
The Palette app opens.

## Changing the background

1. Tap the **Menu** icon .
2. Tap the **Import** icon .
3. Browse to the image you want to use from the display's storage or a USB drive.
4. Tap **OK** to import the image. The image appears on the digital canvas.

### Note

The only way to delete the background is to start a new session.

## Writing and drawing on a palette

1. Select a painting or drawing tool.

If you want, use the slider to customize the line thickness.

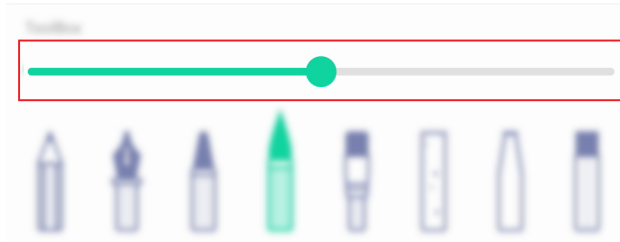

2. Select a color from the ColorBox.

If you want, use the Palette tool to customize the selected color. Start by choosing two colors to mix.

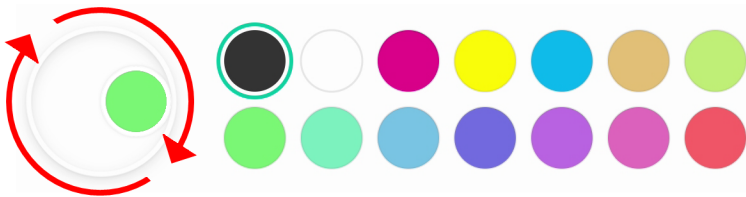

3. Use the display's pens or your finger to paint or draw in digital ink.

## Exiting a palette

When you're done, tap the **Menu** icon , then tap the **Exit** icon .

### Tip

If you want to keep the file, save your work before you exit.



## Using Camera



You can display the video image from a connected Android compatible USB video class (UVC) camera and take a screen capture, which you can modify and annotate before saving it to the display as a .jpg image. You can then import the image into other applications, such as the Whiteboard and Palette apps.

## Viewing, annotating, and saving screen captureshots from a connected camera

### To connect a camera and view its input

1. Connect an Android compatible UVC camera to one of the display's USB Type-A connectors.
2. On the display's Home screen, tap the **Apps** icon .
3. Tap the **Camera** icon .  
The Camera app's main interface appears.
4. Tap the **Setting** icon .
5. Select a connected camera and choose an image resolution.  
The video from the connected camera appears.

### To take a screen capture and add annotations



1. Tap the **Capture picture** icon .  
The camera's video changes to Replay mode and the image is saved to the display.

#### Note

Images are saved on the display in **Storage > VideoPresenter > Photograph > [Dated Folder]**.

2. If you want to go back to the camera preview mode, tap the **Back** icon .









3. Tap any of the these options on the menu bar to adjust the image:

Menu option	Description
 Normal	Picture mode. This is the default preview mode without any visual effects.
 Enhance	Text mode.
 Adjustment	Select options for adjusting the camera's image is displayed, including full screen or auto mode (fixed aspect ratio), changing the size of the image, or rotating the image. You can also select from the following image display options: <ul style="list-style-type: none"> <li>◦ Tap <b>N</b> to switch to normal mode</li> <li>◦ Tap <b>T</b> to reduce color usage and improve text display quality.</li> <li>◦ Tap <b>P</b> to reduce contrast and increase saturation to improve picture quality.</li> </ul> Tap <b>Advanced Options</b> to access controls for dynamically adjusting brightness, contrast, saturation, and sharpness.

4. If you want to makes notes on the screen capture, tap the **Mark** icon .

The *Mark* menu bar appears.



- Tap any of the following options on the menu bar to write or draw in digital ink and save your annotated screen capture. You can also insert a screen capture into a whiteboard file or upload the a screen capture to Google Drive or OneDrive cloud storage.

Menu option	Description
 Select	Exit Pen or Highlighter mode to resume touch functions. For example, tap and hold the image to move its position.
 Pen	Use the display's pens or your finger to write or draw in digital ink.
 Highlighter	Use the Highlighter tool to add emphasis to text or objects.
 Save	Save the current screen capture.
 More	Select from the following options: <ul style="list-style-type: none"> <li>◦ Tap the <b>File</b> icon  to switch to the File manager app to to locate and view previously saved pictures.</li> <li>◦ Tap the <b>Insert</b> icon  to open a new whiteboard and insert the current screen capture.</li> <li>◦ Tap the <b>Cloud</b> icon  to save the current screen capture directly to a Google Drive or OneDrive account.</li> </ul>

- Tap the **Close** icon  to exit the Mark menu and return to the screen capture.

### To view the camera input and previously captured images simultaneously

- Tap the **View** icon  in the bottom-right corner of the screen.
- Tap any of these options on the menu bar in the bottom-right corner of the screen.

Menu option	Description
 Double	Show the current camera preview on the left half of the screen and a previously saved picture on the right half.
 Four	Show the current camera preview in the top-left quadrant of the screen and up to three previously saved pictures in the other three quadrants.
 Preview	Load a different, previously captured picture into this preview location.

- Tap the **Close** icon  to exit the view menu and return to the video from the connected camera.



## Exiting Camera

When you're done, tap the **Exit** icon  in the bottom-left corner of the screen.



## Using Clean



Use the Clean app to optimize the display's system memory and delete files in the trash.

### Opening and closing the Clean app

#### To open the Clean app

1. On the display's Home screen, tap the **Apps** icon .
2. Tap the **Clean** icon .

The Clean app's main interface appears.

#### Note

To check the version information of the Clean app, tap the **Info** icon  in the lower-left corner.

#### To close the Clean app

To exit the Clean app, tap the **Exit** icon  in the lower-left corner.

## Using the One Key Optimize tool

Use the One Key Optimize tool to clear the display's system memory, detect hardware issues, and clear the display's deleted files (trash) at the same time.

1. Tap **One Key Optimize** to start.
2. Wait for the app to finish.

You can **Optimize Again** or exit the app when finished.

## Using the Clean Memory tool

Use the Clean Memory tool to clear the display's system RAM.

1. Tap the **Clean Memory** icon .
2. Wait for the app to finish.

You can **Optimize Again** or exit the app when finished

## Using the Clean Trash tool

Use the Clean Trash tool to clear the display's deleted files (trash).

1. Tap the **Clean Trash** icon .
2. Wait for the app to finish.



You can **Clean Again**, or exit the app when finished.

## Using Cloud Drive



Use the Cloud Drive app to set up the display to save or retrieve items from a Google Drive or OneDrive account (requires an existing Google Drive or OneDrive account).

### To open the Cloud Drive app

1. On the display's Home screen, tap the **Apps** icon .
2. Tap the **Cloud Drive** icon .

### To add an account

1. Tap **Add Account**.
2. Choose an account type by tapping **Google Drive** or **OneDrive**.
3. Enter your account email and password, and **Allow** permissions when prompted.

If you want, repeat steps 1 to 3 to add more accounts.

4. To set an account as the display's default account, select the account and tap **Set as default**.

If you want to make the account no longer the default, tap **Cancel the default**.

If you want to sign out from an account, tap **Logout**.

5. Tap the **Close** icon  to exit.

## Using WPS Office





You can use the Writer, Presentation, and Spreadsheet features of this office suite to create or view a variety of document types. WPS Office can also open and edit documents created with a variety of other software, including Microsoft Office, Google Docs, and Adobe Acrobat.

### Note

WPS is a third-party application. SMART's support for this application may vary depending on the inquiry.

## Opening the WPS Office app

1. On the display's Home screen, tap the **Apps** icon .
2. Tap the **WPS Office** icon .

The WPS Office welcome screen appears.

## Using the WPS Office app

For information about using WPS office, see the [help.wps.com/](http://help.wps.com/) support site.



## Using File manager



Use the File manager to access files saved on the display, on USB drives, or in Google Drive or OneDrive cloud storage. Sign into the cloud account and grant permissions before using File manager to access that account.

You can also open saved whiteboard .enb or .png files in the File manager.

## Opening File manager

1. On the display's Home screen, tap the **Apps** icon .
2. Tap the **File** icon .

The File manager appears.

## Viewing files

### To view a whiteboard file saved from the Whiteboard app

1. In File manager, browse to the folder that contains the saved whiteboard file and double-tap it.

#### Note

The default folder location for saving Whiteboard files in File Manager is *Whiteboard*. See *Using Whiteboard* on page 29.

2. Double-tap the Whiteboard file (.enb) to open it.

### To view a picture, play an audio file, or watch a video

1. In File manager, browse to and double-tap the file.

#### Tip

Common storage locations for picture and video files are the DCIM, Pictures, Video Presenter, Movies, and Palette folders.

2. The file opens in the appropriate application.

#### Tip

Swipe the screen left or right to see view all the images in that folder.

### To stop viewing the file

On the display's **Toolbar**, tap the **Home** icon . See *Toolbar* on page 19.



## Moving or copying files

### Using a USB drive

#### To move or copy a file from a USB drive to the display

1. Connect a USB drive to the display on the front connector panel.



2. On the display's Home screen, tap the **Apps** icon .
3. Tap the **File** icon .

4. Tap the name of the connected USB Drive.
5. Browse to the files you want to move or copy.
6. Tap a file to select it.

OR

Tap **Select** to select multiple files. A check box appears next to the selected files.

7. Tap **Cut** or **Copy** in the bottom menu.

**Note**

**Cut** will remove the file from the USB drive, whereas **Copy** will leave the file on the USB drive.



8. Tap **Storage**.
9. Browse to the folder you want to move the file to.
10. Double-tap the folder to open it.
11. Tap **Paste**.

The file is copied or moved to the display.

**To move or copy a file from the display to a USB drive**

1. Connect a USB drive to the display on the front connector panel.



2. On the display's Home screen, tap the **Apps** icon .
3. Tap the **File** icon .
4. Tap **Storage**.
5. Browse to the files you want to move or copy.
6. Tap the file to select it.

OR

Tap **Select** to select multiple files. A check box appears next to the selected files.

7. Tap **Cut** or **Copy** in the bottom menu.

**Note**

**Cut** will remove the file from the display, whereas **Copy** will leave the file on the display.

8. Tap the name of the connected USB Drive.
9. Browse to the folder you want to move or copy the file to.



10. Double-tap the folder to open it.
11. Tap **Paste**.

The file is copied or moved to the USB drive.

### **Using a Google Drive or OneDrive account**

The following procedures require that you first set up the display to save or retrieve items from a Google Drive or OneDrive account. For more information, see *Using Cloud Drive* on page 66.

#### **To move or copy a file from a cloud drive to the display**

1. On the display's Home screen, tap the **Apps** icon .
2. Tap the **File** icon .
3. Tap **Cloud Drive**.
4. Browse to the files you want to move or copy.
5. Tap the file to select it.

OR

Tap **Select** to select multiple files. A check box appears next to the selected files.

6. Tap **Cut** or **Copy** in the bottom menu.



#### **Note**

**Cut** will remove the file from the Cloud drive, whereas **Copy** will leave the file on the USB drive.

7. Tap **Storage**.
8. Browse to the folder you want to move the file to.
9. Double-tap the folder to open it.
10. Tap **Paste**.

The file is copied or moved to the display.

#### **To move or copy a file from the display to a cloud drive**

1. On the display's Home screen, tap the **Apps** icon .
2. Tap the **File** icon .
3. Tap **Storage**.
4. Browse to the files you want to move or copy.

5. Tap the file to select it.

OR

Tap **Select** to select multiple files. A check box appears next to the selected files.

6. Tap **Cut** or **Copy** in the bottom menu.

**Note**

**Cut** will remove the file from the display, whereas **Copy** will leave the file on the display.

7. Tap **Cloud Drive**.
8. Browse to the folder you want to move or copy the file to.
9. Double-tap the folder to open it.
10. Tap **Paste**.

The file is copied or moved to the Cloud drive.

## Installing apps using File Manager

You can use File manger to install third-party apps on the display.

 **Important**



The installation of third-party apps works only if you've enabled the option *Unknown sources* in **Display Settings > System > Security > Install from unknown sources** (it is disabled by default).

See *SMART Board GX (V2) series interactive displays installation and maintenance guide* ([smarttech.com/kb/171861](http://smarttech.com/kb/171861)).

### To install apps using File Manager

1. Download and save Android Package files (.apk) to a USB Drive.
2. Connect the USB drive to the display on the front connector panel.



3. On the display's Home screen, tap the **Apps** icon .
4. Tap the **File** icon .
5. Tap the name of the connected USB Drive.
6. Browse to and double-tap the .apk file you want to install.

Follow the on-screen instructions to install the app on the display.

## Supported file formats

For more information regarding supported file formats, see [Supported Media Formats](#).

## Using SMART Remote Management



You can use SMART Remote Management on the display.

For more information, see the *SMART Board GX (V2) series interactive displays installation and maintenance guide* ([smarttech.com/kb/171861](http://smarttech.com/kb/171861)).

## Using Settings



Access the display's settings to configure network and Wi-Fi settings, user interface controls, toolbar display options, and input and output device connection settings. You can also configure apps, see system settings, view regulatory information, and more.

For more information, see the *SMART Board GX (V2) series interactive displays installation and maintenance guide* ([smarttech.com/kb/171861](http://smarttech.com/kb/171861)).

## Unsupported apps

Some apps can cause issues with GX (V2) displays and are not supported on these displays as a result.

Icon	Notes
Launchers	Launcher apps can interfere with the home screen app and cause the Input, Screen Share, and other apps to stop working.
Web browsers	Third-party web browsers allow users to download APKs and other files from the internet.
File managers	File managers can allow access to hidden system files and settings.
Keyboards	Third-party keyboards can cause a wide variety of issues with the embedded Android experience.
Setup wizards, system setting tuners, and apps that allow the system to be rooted	These apps grant access to the operating system and can cause a wide variety of issues.
Online music players	Online music players can operate in the background. The interface is hidden and you can't stop unintended music from playing.



<b>Icon</b>	<b>Notes</b>
Apps requiring Google Play Services	Google's policies do not permit Google Play Services to be used on interactive display products. Apps requiring Google Play Services will not run on SMART Board GX (V2) interactive displays with embedded Android, and attempts to run them could cause problems.
Apps with GPS	Hardware limitations prevent apps from working.
Apps with NFC	Hardware limitations prevent apps from working.
Apps that require portrait orientation	Apps that require portrait orientation don't fit the landscape screen. Install only apps that allow landscape orientation.

# Chapter 3 Using widgets on the display

Input Settings menu .....	76
Using the Overlay widget .....	76
Overlay tools and controls .....	77
Using the Timer widget .....	78
Using Stopwatch .....	80
Using the Spotlight widget .....	82
Using the Record widget .....	83
Using the Freeze widget .....	85
Using the PIP widget .....	86
Using the Split screen widget .....	87
Using Screen lock .....	88
Using the Calculator tool .....	88
Using the Screen Capture widget .....	89

This chapter introduces the widgets on the SMART Board GX (V2) series interactive displays.

To open the widget menu, open the **Toolbar** menu (see *On-screen menus and controls* on page 18) and tap the **More** icon .

You can also pin the widgets you use regularly to the Toolbar (see *Favorite widget shortcuts* on page 21).

## Note

Widgets always appear on top of other open windows, programs, and connected devices.

The tools menu features the following tools and controls:

Icon	Widget	Function	For more information
	Input	Select an input and adjust brightness and volume. You can also access advanced options for configuring input settings.	See the <i>SMART Board GX (V2) series interactive displays installation and maintenance guide</i> ( <a href="http://smarttech.com/kb/171861">smarttech.com/kb/171861</a> ).

Icon	Widget	Function	For more information
	Overlay	Write on an overlay on top of any app, video, website, document, or image, including input from a connected computer. Saving to cloud storage is also supported.	<i>Using the Overlay widget on the next page</i>
	Timer	Start a countdown timer.	<i>Using the Timer widget on page 78</i>
	Stopwatch	Start a stopwatch that counts up from zero for measuring elapsed time.	<i>Using Stopwatch on page 80</i>
	Spotlight	Use the Spotlight widget during a presentation to draw attention to an area of a screen.	<i>Using the Spotlight widget on page 82</i>
	Record	Use the Record widget to record your actions on the display.	<i>Using the Record widget on page 83</i>
	Freeze	Freeze and zoom the current image on the screen.	<i>Using the Freeze widget on page 85</i>
	PIP	Use the picture-in-picture (PIP) widget to show a different input in a smaller floating window while using other apps on the display.	<i>Using the PIP widget on page 86</i>
	Split screen	Use the Split screen widget to divide the screen into two parts, allowing you to use two different apps or widgets simultaneously.	<i>Using the Split screen widget on page 87</i>
	Screen lock	Lock the screen.	<i>Using Screen lock on page 88</i>
	Calculator	Open an on-screen calculator.	<i>Using the Calculator tool on page 88</i>

Icon	Widget	Function	For more information
	Screen Capture	<p>Capture screen captures of anything on the screen, including content from apps, websites, and videos.</p> <p>Select Freedom, Full, and window mode.</p> <p>You can add captured screens to a whiteboard and edit them.</p>	<i>Using the Screen Capture widget on page 89</i>

## Input Settings menu



Select an input and adjust brightness and volume. You can also access advanced options for audio, screen, display, and image adjustment.

See the *SMART Board GX (V2) series interactive displays installation and maintenance guide* ([smarttech.com/kb/171861](http://smarttech.com/kb/171861)).

## Using the Overlay widget

Use the Overlay widget to write or draw over the currently displayed screen contents. After you finish, you can save the overlay to the Files library. You can also save overlays directly to a Google Drive or OneDrive account.

### To write or draw on an overlay

1. Tap the **Overlay** icon .
2. Use the display's pens or your finger to write or draw in digital ink.
3. If you want to keep the overlay, tap the **Save** icon  to save the image file to the display in .png format.

OR

Tap the **More** icon  and then the **Cloud Drive** icon  to save the file to your Google Drive or OneDrive account.

This will also save a copy of the .png file locally.

4. When you're done, tap the **Close** icon  to exit the overlay.

**To erase ink on an overlay**

Erase ink by moving your fist or palm over the digital ink.

OR

Tap the **Clean** icon  and erase all the ink.

Overlay tools and controls

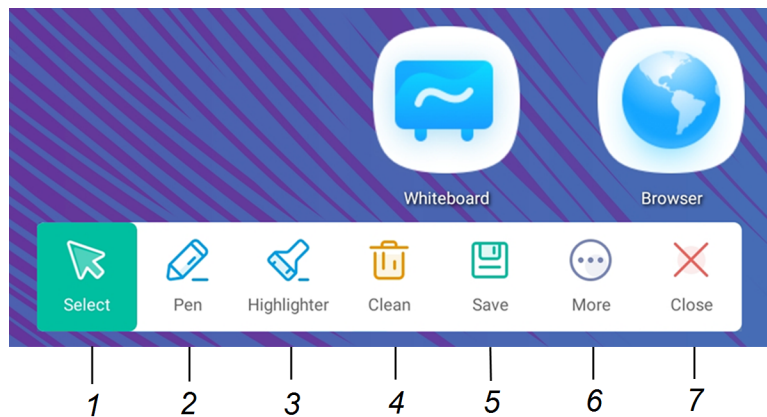

No.	Tool
1	Select tool. When the Select tool is active, your touch passes through the overlay and interacts with the screen contents behind it.
2	Pen tool. When the Pen tool is active, your touch draws digital ink on the overlay. Options are available for pen size and color.
3	Highlighter tool. When the Highlighter tool is active, your touch draws transparent digital ink on the overlay. Options are available for pen size and color.
4	Erase all digital ink on the overlay.
5	Save the current overlay.
6	Open File manager, insert an image, and access cloud storage.
7	Remove the overlay and close the Overlay widget.

## Using the Timer widget

Use the Timer widget to display a countdown timer on the screen.

### To use the Timer widget

1. Tap the **Timer** icon .

The Timer widget opens:

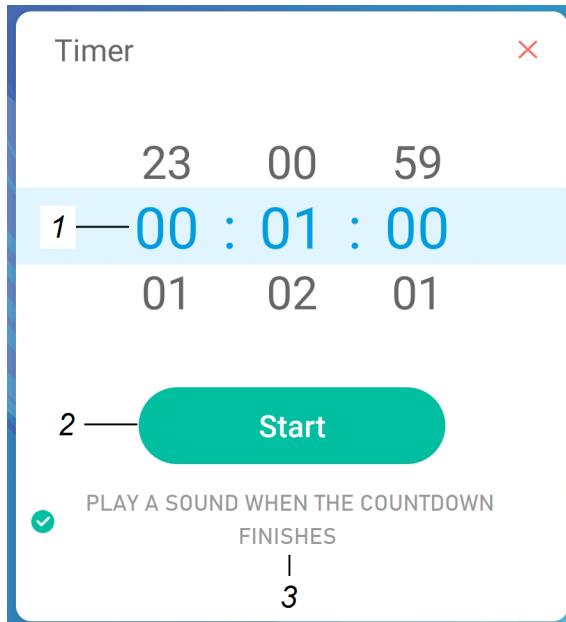

No.	Tool
1	Timer display (left to right): hours, minutes, seconds. Slide your finger up or down on the numbers to customize the countdown timer.
2	Start the countdown timer.
3	(Optional) Enable the <b>PLAY A SOUND WHEN THE COUNTDOWN FINISHES</b> option to add an audible ring tone that sounds when the timer ends.

2. Tap **Start** to start the countdown timer.

This image and table describe the options available after the timer has started:

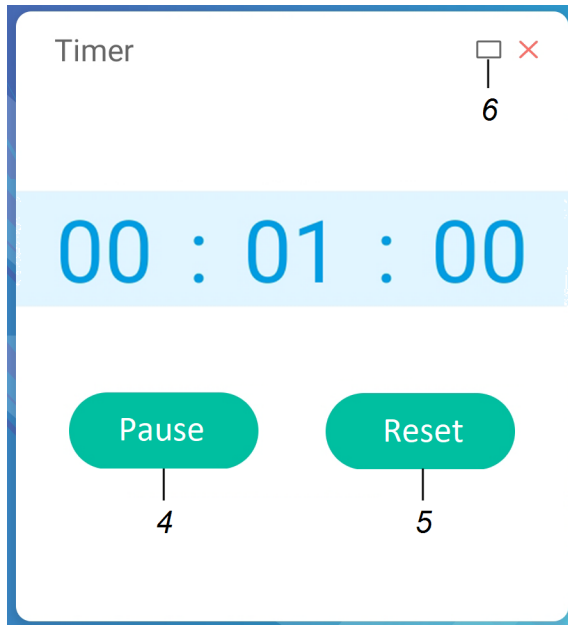

No.	Tool
4	Pause the countdown timer.
5	Reset the countdown timer.
6	Make the countdown timer full screen. Tap again to return to normal size. Tap the screen anywhere other than the timer to make the timer a moveable floating window and move it around.

### To close the Timer widget

Tap the **Close** icon .

## Using Stopwatch

Use the Stopwatch widget to count up from zero and measure elapsed time.

### To use the Stopwatch widget

1. Tap the **Stopwatch** icon .

The Stopwatch tool opens:

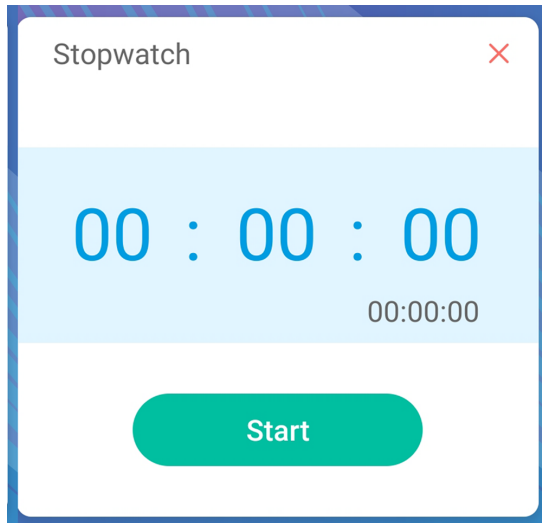



2. Tap **Start** to start the stopwatch.

This image and table describe the options available after the stopwatch has started:

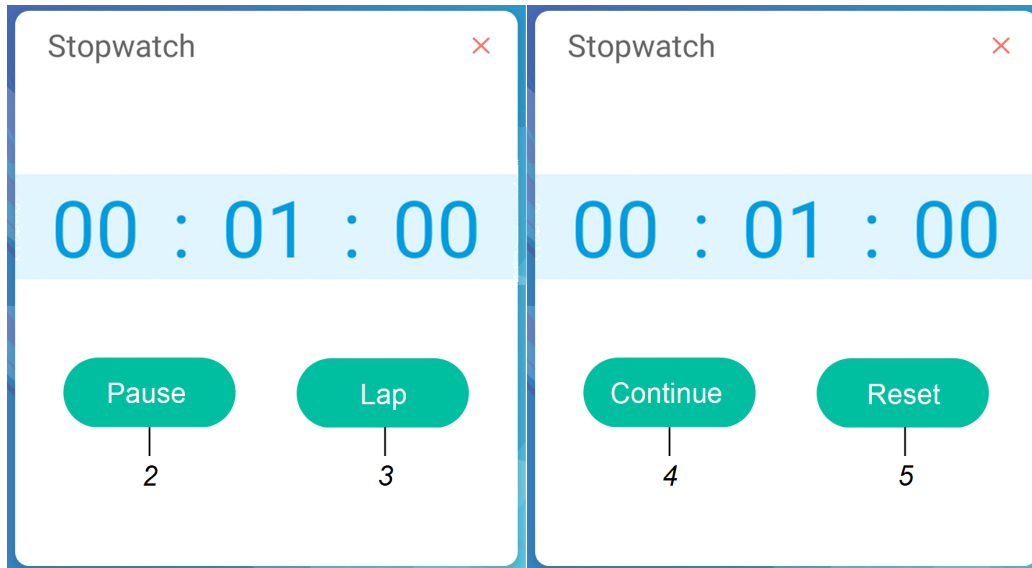

No.	Tool
2	Pause the stopwatch.
3	Record the current time and display it in a list of other times you've recorded.
4	Resume the stopwatch after pausing.
5	Reset the stopwatch to zero.

### Tip

You can turn the Stopwatch widget into a moveable floating menu by tapping a different part of the screen.

### To close the Stopwatch widget

Tap the **Close** icon

## Using the Spotlight widget

You can use the Spotlight widget during a presentation to draw attention to a particular screen area.

### To use the Spotlight widget

1. Tap the **Spotlight** icon .

The Spotlight widget is activated:

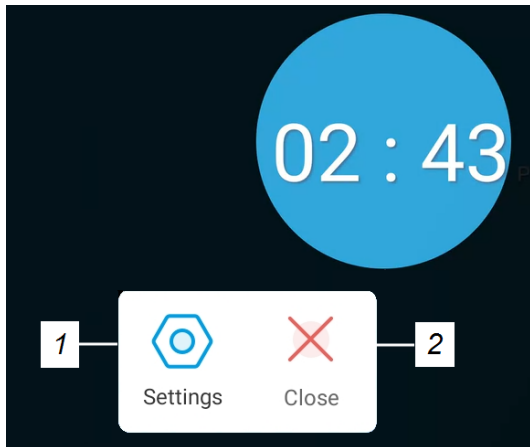

No.	Tool
1	Open Settings for controls that change the spotlight's size and transparency. <b>Tip</b> You can also use finger gestures to change the size of the spotlight area.
2	Close the Spotlight widget.

2. Press and drag the Spotlight window to highlight an area of the screen.

### To close the Spotlight widget

Tap the **Close** icon .

## Using the Record widget

You can use the Record widget to record a video of the on-screen activity.

### To use the Record widget

1. Tap the **Record** icon .

The Record widget opens:

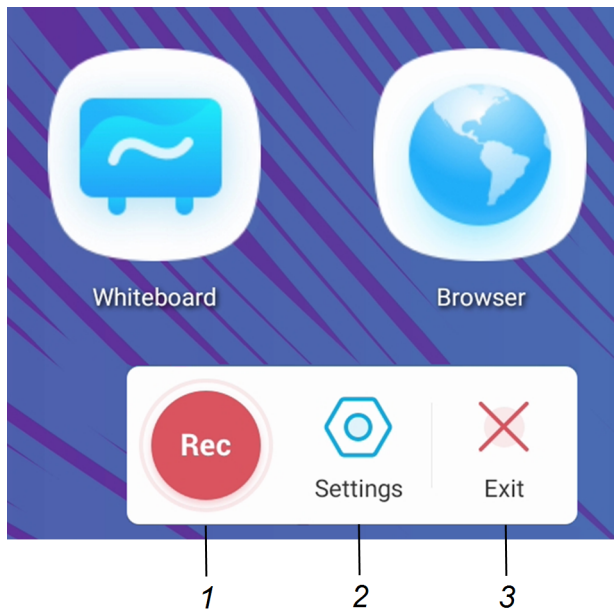

No.	Tool
1	Begin recording.
2	Open Settings for controls that change the video's resolution and to select a location for the saved recording.
3	Close the Record widget.

2. (Optional) Tap **Settings** and change the default resolution and the location of the saved recording.
3. Tap the **Rec** icon  to begin recording your actions on the display.



4. If you want to pause the recording, tap the **Pause** icon .



To resume recording, press the **Resume** icon .

5. To stop the recording, tap the **Stop** icon .

The recording is saved to the display.

#### **To close the Record widget**

Tap the **Exit** icon .

## Using the Freeze widget

You can use the Freeze widget to temporarily freeze the screen.

### Note

Freezing the screen does not pause running applications on the connected computer. It simply freezes the display of those applications.

### To use the Freeze widget

1. Tap the **Freeze** icon .

The Freeze widget appears and the screen is temporarily frozen:

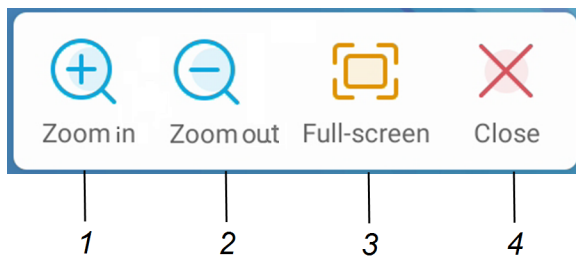

No.	Tool
1	Zoom into the current screen. <b>Tip</b> You can also use pinch-to-zoom finger gestures to zoom in or out.
2	Zoom out from the current screen.
3	Return to the default screen size.
4	Close the Freeze widget.

2. Press and drag the frozen image to move it on the screen, and use the zoom controls to focus on a specific detail.

### To close the Freeze widget

Tap the **Close** icon .

# Using the PIP widget

The picture-in-picture (PIP) widget enables you to show a different input in a smaller floating window you can position anywhere on the screen. The floating window appears on top of open apps, allowing you to continue viewing the second input while interacting with other apps or websites.

## To use the PIP widget

1. Tap the **PIP** icon .

The PIP widget opens:

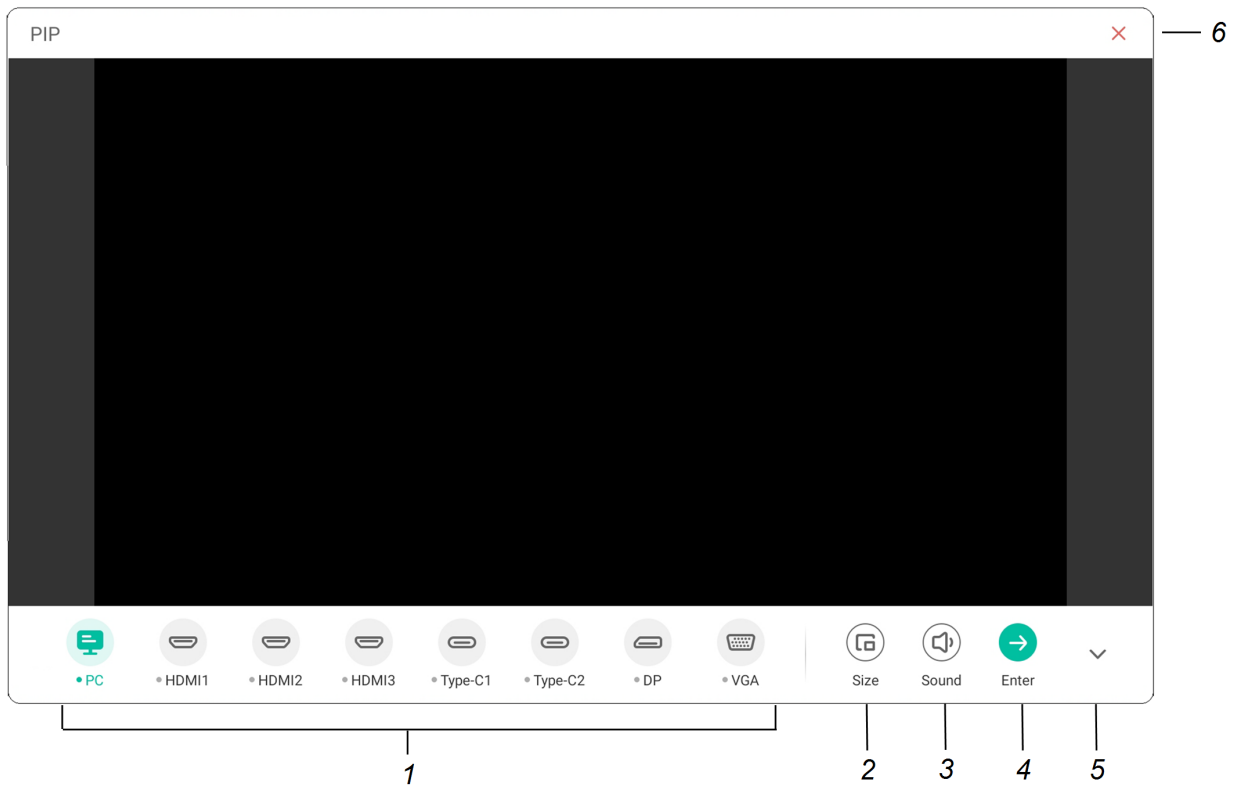

No.	Tool
1	Select an input.
2	Choose a size for the floating window (small, medium, or large).
3	Increase, decrease, or mute the input volume.
4	Display the input in full screen.
5	Hide the menu items.
6	Close the PIP widget.

2. Tap an input to appear in the second window.
3. Tap the **Enter** icon  to view the selected input in full screen.

**Note**

If selected input also has a USB cable connected for touch, you can control this input via touch, directly within the PIP window.

**To close the PIP widget**

Tap the **Close** icon .

## Using the Split screen widget

The Split screen widget divides the screen into two parts, allowing you to use two different apps or widgets simultaneously. Display two documents or images side-by-side, or play a video on one half of the screen while taking notes on the other half.

**Note**

The Split screen widget doesn't support simultaneous digital ink in the two apps.

**To use the Split screen widget**

1. Tap the **Split screen** icon .

A list of apps that support the Split screen feature appears.

2. Select an app.

The selected app opens on one half of the screen.

3. Select a second app.

The second app opens beside the first open app.

**To close the Split screen widget**

Use the controls in the open apps to close each app.

## Using Screen lock

Use the Screen lock feature to secure the display's screen. When the Screen lock is enabled, a four digit passcode must be entered to unlock the screen.

### Note

Creation of a Screen lock passcode is part of the display's initial set up. You can also configure the Screen lock feature in display settings.

See the *SMART GX (V2) series interactive displays installation and maintenance guide* ([smarttech.com/kb/171861](http://smarttech.com/kb/171861)).

### To lock the screen

Tap the **Screen lock** icon .

A passcode must now be entered to unlock the screen.

## Using the Calculator tool

Open an on-screen calculator that appears on top of applications running on the display.

### To use the Calculator widget

Tap the **Calculator** icon .

To close the Calculator widget, tap the **Close** icon .



## Using the Screen Capture widget

The Screen Capture toolbar enables you to take a screen capture of a rectangular area or the entire screen.

### To use the Screen Capture tool

1. Tap the **Screen Capture** icon .

The Screen Capture tool opens:

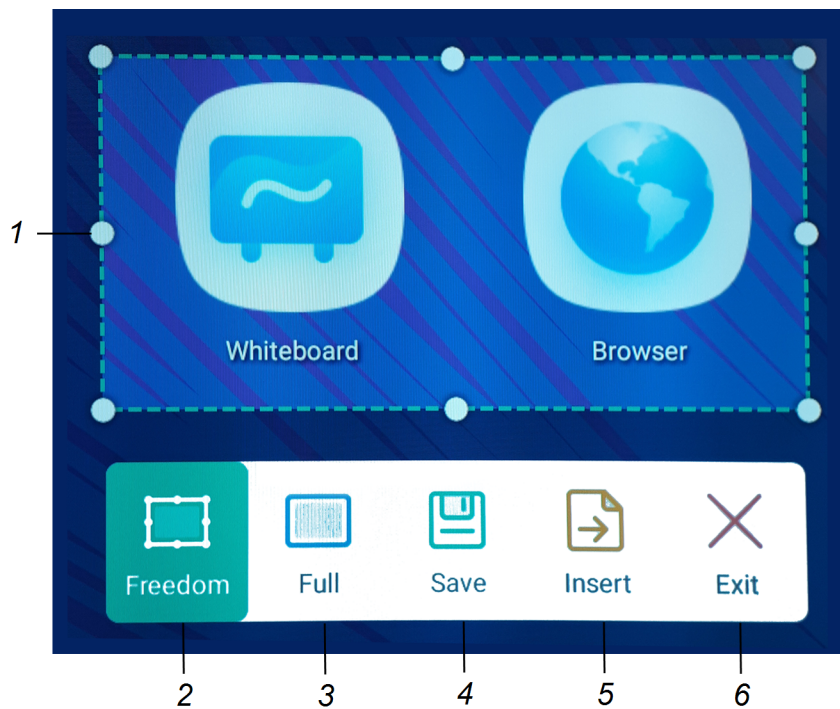

No.	Tool
1	Capture window resize handles.
2	Select a resizable rectangular window.
3	Select the entire screen.
4	Save the selected window or screen.
5	Insert the selected window or screen into a new whiteboard.
6	Close the Screen Capture widget

2. Select the area or screen you want to capture.

3. Tap the **Save** icon  to save the selected window or screen.  
The captured image is saved on the display to the default folder.
4. Tap **Finish** to continue working on the display, or **Open** to see the save image in the destination folder.
5. If you've opened the destination folder, you can move or copy the file to a USB drive or uploaded to your Google Drive or OneDrive account (see *Moving or copying files* on page 68).

OR

Tap the **Insert** icon  to insert the selected window or screen into a new whiteboard.

#### **To close the Screen Capture widget**

Tap the **Close** icon .

# Chapter 4 Connecting computers and other devices

Installing and using SMART software .....	91
Downloading and installing SMART software .....	92
Using SMART software .....	92
Connecting room computers and guest laptops .....	92
Viewing a connected computer or other device's input .....	99
Setting a connected computer's resolution and refresh rate .....	100
Using recommended cables .....	101
Sharing USB Type-B receptacles .....	102
Connecting a SMART OPS PC module .....	103
Connecting USB drives, peripherals, and other devices .....	104

## Warning

Ensure that any cables that cross the floor to the display are properly bundled and marked to avoid a trip hazard.

## Installing and using SMART software

The display comes with the following software, which you can install on connected computers:

Software	Description	Notes
SMART Notebook	Free software designed for use with a SMART Board interactive display. SMART Notebook software comes with many features that you can use to create, edit, and deliver engaging lessons for your students.	See <a href="#">SMART Notebook</a> .
SMART Product Drivers	Software that enables the computer to detect input from the display.	Included with SMART Notebook.
SMART Ink	Software that enables you to write and draw in digital ink over applications, files, folders, websites, and any other open window.	Included with SMART Notebook.

The following software is also available but sold separately:

Software	Description	Notes
SMART Learning Suite	A suite of desktop and online software that combines lesson delivery, activities, assessments, and collaborative workspaces. Includes SMART Notebook Plus software and Lumio by SMART.	For more information, see <a href="#">SMART Learning Suite</a> .
SMART Meeting Pro	Software that enables you to capture ideas in a virtually unlimited interactive workspace.	For more information, see <a href="#">SMART Meeting Pro</a> .
SMART TeamWorks Room	Software that simplifies meetings and facilitates deeper, more natural interaction with onsite and remote participants.	For more information, see <a href="#">SMART TeamWorks</a> .
SMART Remote Management	Cloud-based mobile device management software for remotely maintaining, supporting, controlling, and securing the display and your other devices.	For more information, see <a href="#">SMART Remote Management</a> .

Contact your authorized SMART reseller ([smarttech.com/where](http://smarttech.com/where)) for information about purchasing SMART software.

## Downloading and installing SMART software

You can download SMART software from [smarttech.com/downloads](http://smarttech.com/downloads).

## Using SMART software

For information about using SMART software, see the following pages in the Support section of the SMART website:

- [SMART Notebook](#)
- [SMART Product Drivers and Ink](#)

## Connecting room computers and guest laptops

You can connect room computers and guest laptops to the display to view and interact with them.

### Notes

- Install SMART software on computers you connect to the display (see *Installing and using SMART software* on the previous page).
- Make sure [SMART Product Drivers 12.20](#) or later are installed on any connected computers.

- Your organization’s installers might have connected cables to the display and run the cables behind a wall or under the floor to a desk or table where you can place your computer.
- As shown below, HDMI 1, HDMI 2, VGA, and Display Port share the Touch USB Type-B receptacle on the side connector panel, and HDMI 3 uses the Touch USB Type-B receptacle on the front connector panel (see *Sharing USB Type-B receptacles* on page 102).
- The USB Type-C connector on the front connector panel provides up to 15 W of power for charging connected devices.

The following are the locations of the connectors and the connector and cable information for the display’s inputs.

- **USB Type-C 1**

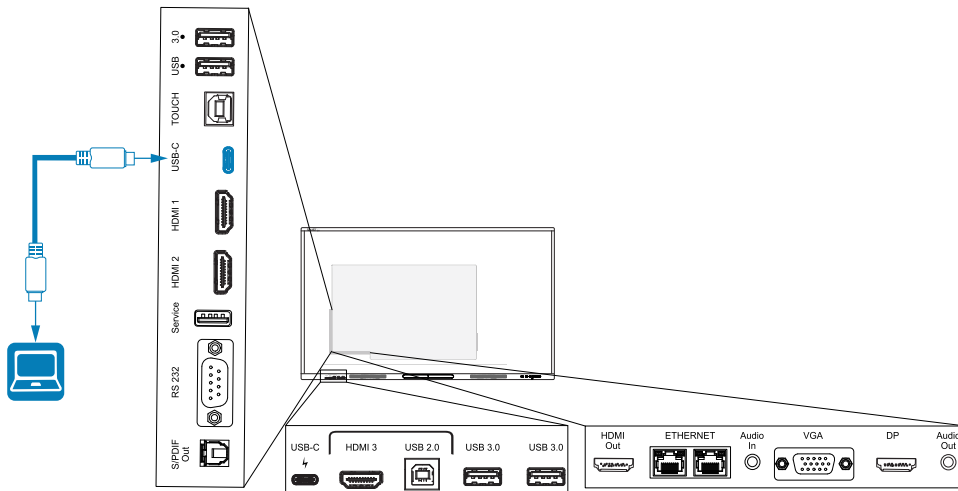

Connector	Standard	Connection type	Cable
USB Type-C 1	USB-C	Video/audio/touch	<u>SuperSpeed USB Type-C</u>

- **USB Type-C 2**

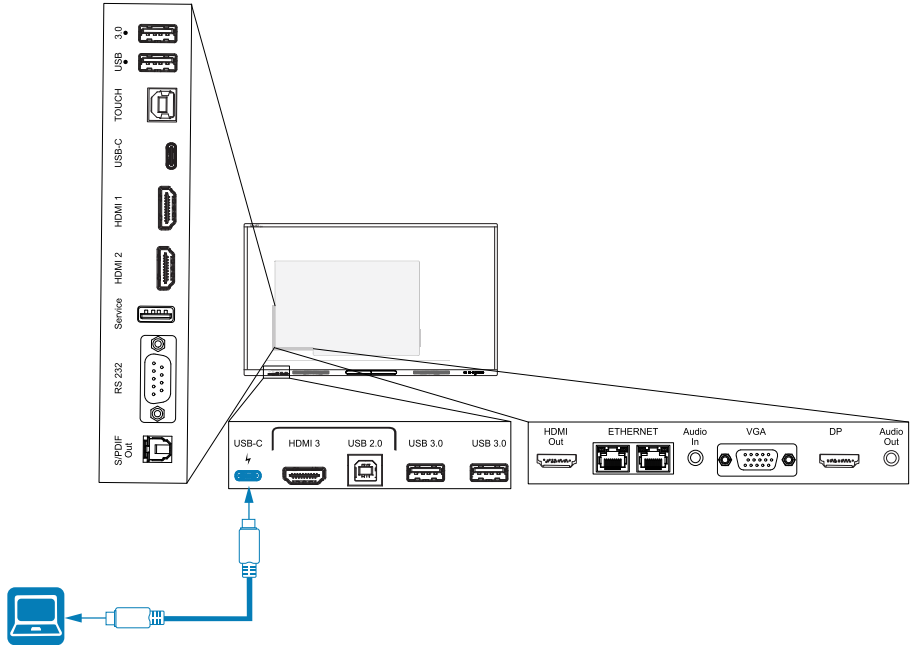

Connector	Standard	Connection type	Cable
USB Type-C 2	USB-C	Video/audio/touch	<u>SuperSpeed USB Type-C</u>

- HDMI 1

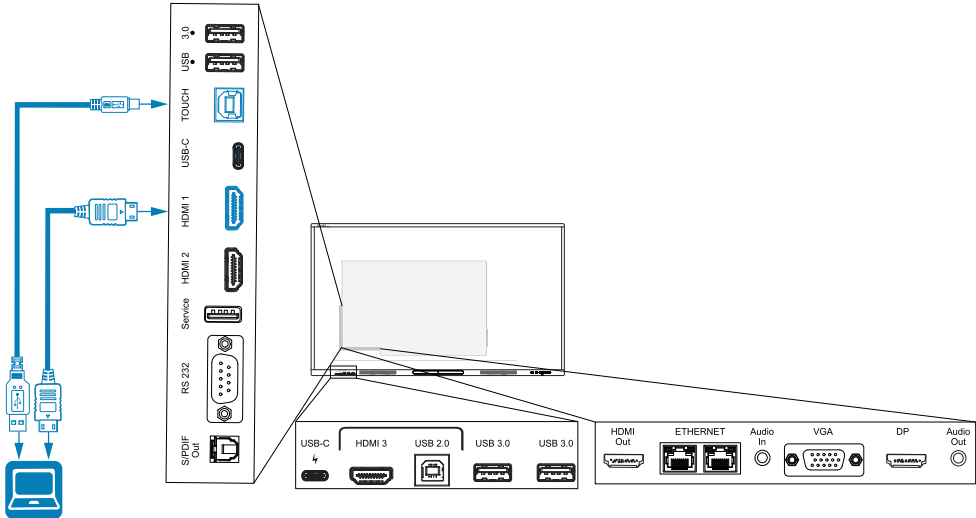

Connector	Standard	Connection type	Cable
HDMI 1	HDMI 2.0	Video/audio	<u>Premium High Speed HDMI (18 Gbps)</u>
Touch	USB 2.0 Type-B	Touch	<u>High Speed (480 Mbps) USB 2.0</u>

- **HDMI 2**

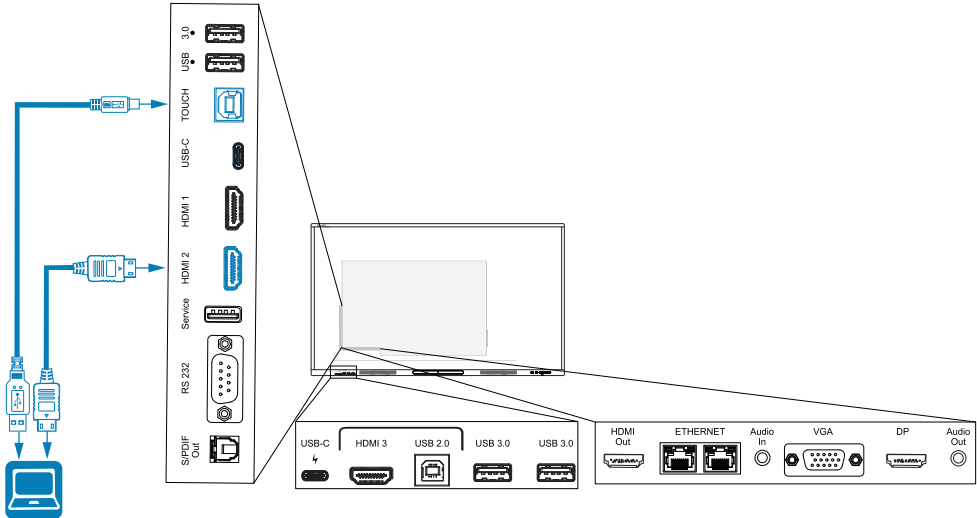

Connector	Standard	Connection type	Cable
HDMI 2	HDMI 2.0	Video/audio	<u>Premium High Speed HDMI (18 Gbps)</u>
Touch	USB 2.0 Type-B	Touch	<u>High Speed (480 Mbps) USB 2.0</u>



- **HDMI 3**

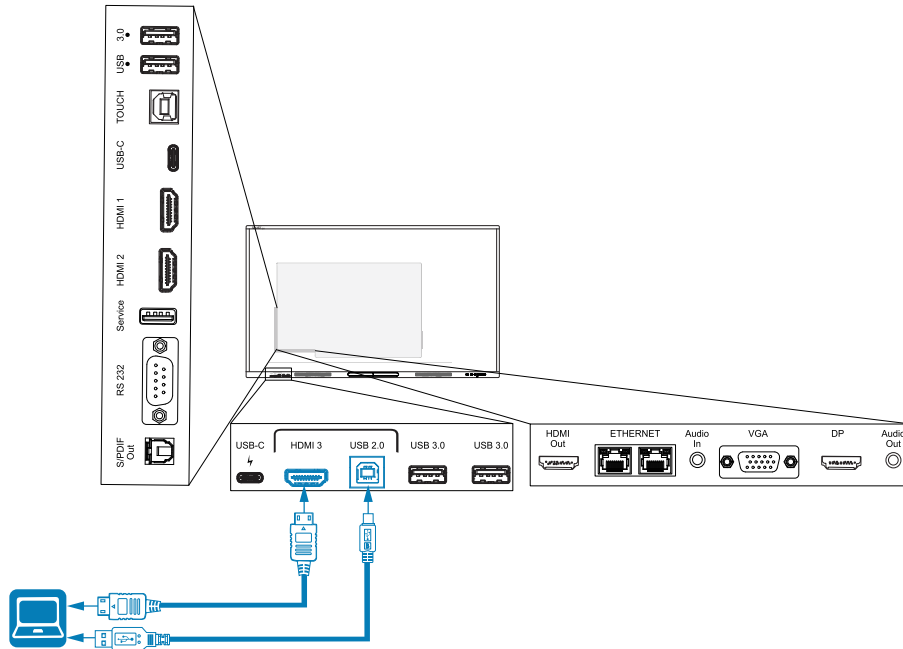

Connector	Standard	Connection type	Cable
HDMI 3	HDMI 2.0	Video/audio	<u>Premium High Speed HDMI (18 Gbps)</u>
Touch input	USB 2.0 Type-B	Touch	<u>High Speed (480 Mbps) USB 2.0</u>

- **Display Port**

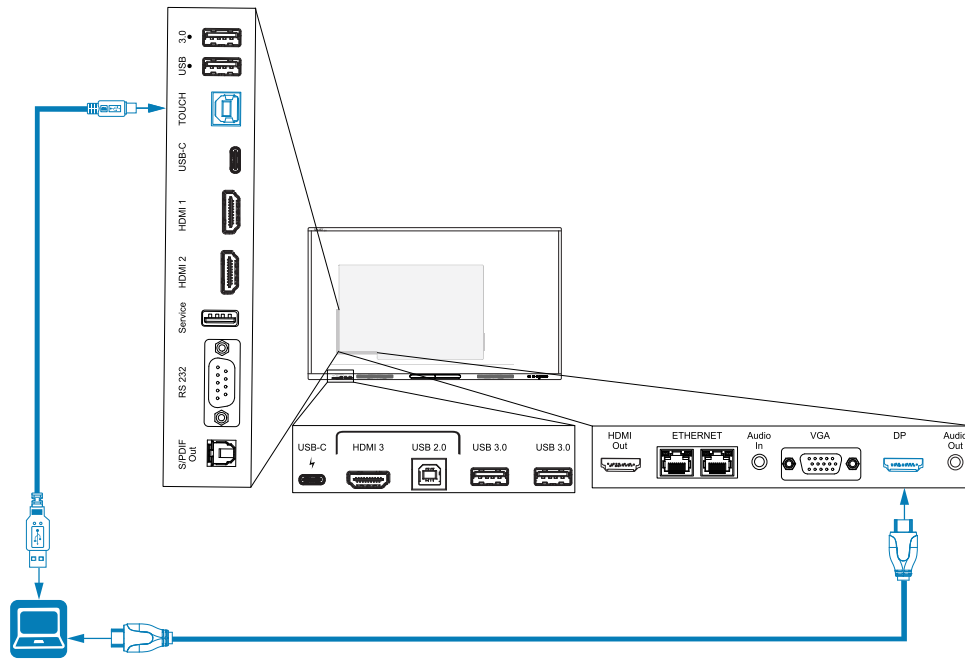

Connector	Standard	Connection type	Cable
Display Port	Display Port 1.2	Video/audio	<u>Display Port</u>
Touch	USB 2.0 Type-B	Touch	<u>High Speed (480 Mbps) USB 2.0</u>

• **VGA**

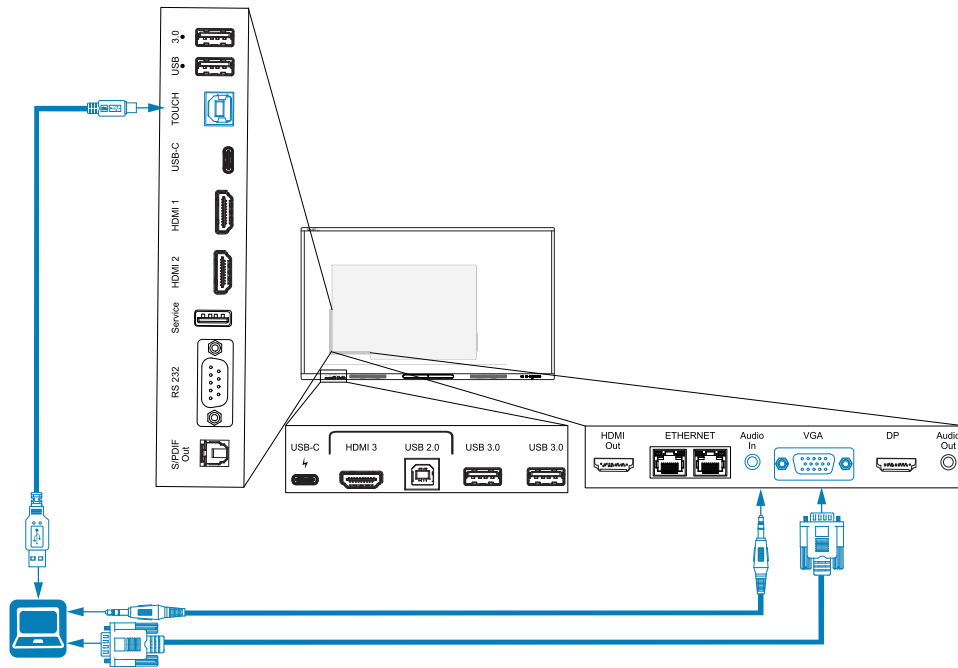

Connector	Standard	Connection type	Cable
VGA	VGA	Video	<u>VGA</u>
Audio In	Stereo 3.5 mm	Audio	<u>Stereo 3.5 mm</u>
Touch	USB 2.0 Type-B	Touch	<u>High Speed (480 Mbps) USB 2.0</u>





### Viewing a connected computer or other device's input

1. Connect a device to the display's HDMI 1, HDMI 2, HDMI 3, USB Type-C 1, USB Type-C 2, Display Port, or VGA connectors.

**Note**

To enable touch control of the device, connect a USB cable to the associated USB connector. Devices connected to the USB Type-C connector don't require an additional USB connection to enable touch.

2. Select the source using one of the following methods:

Using the Input settings menu	Using the remote control
<ol style="list-style-type: none"> <li>Open the <b>Toolbar</b> by tapping one of the side Toolbar buttons  (on either sides of the screen).</li> <li>Tap the <b>Input</b> icon .</li> </ol> <p><b>Tip</b></p> <p>Tap the <b>More</b> icon  to find the Input icon if it doesn't appear in the Favorite widgets list in the Toolbar.</p> <p>See <i>Toolbar</i> on page 19.</p>	<p>Press the <b>Input</b> icon .</p>

**Note**

A green circle  appears around the currently selected input (PC, Android, HDMI1, HDMI2, HDMI3, Type-C1, Type-C2, DP, or VGA). Inputs with a connected source have a green dot beside the input name, rather than a gray dot. The input name also appears in green text rather than gray when an input is connected.

3. Tap the computer's input or use the navigation keys on the remote control to select the source and then press the **OK** button.

The device's output appears on the display's screen.

**Tip**

You can rename inputs, enable or disable inputs, configure the display to turn on when an active video signal is connected, and automatically switch the input when an active video signal is connected.

See the *SMART Board GX (V2) series interactive displays installation and maintenance guide* ([smarttech.com/kb/171861](http://smarttech.com/kb/171861)).

## Setting a connected computer's resolution and refresh rate

This table presents the recommend resolutions and refresh rates for the display's inputs:

Input	Maximum resolution	Refresh rate
USB Type-C, Display Port Alternate Mode	3840 × 2160	60 Hz

Input	Maximum resolution	Refresh rate
HDMI 1 <sup>1</sup>	3840 × 2160	60 Hz
HDMI 2	3840 × 2160	60 Hz
HDMI 3	3840 × 2160	60 Hz
VGA	1920 × 1080	60 Hz
Display Port	3840 × 2160	60 Hz
PC2	3840 × 2160	60 Hz

If possible, set connected computers to these resolutions and refresh rates. See the computers' operating system documentation for instructions.

## Using recommended cables

SMART recommends the following varieties of cable:

Cable type	Maximum length	Recommendation
Display Port	23' (7 m) <sup>3</sup>	Use only certified Display Port 1.4 cables that have been tested to support the performance standard you require.
HDMI	23' (7 m)	Use only certified premium high-speed HDMI cables that have been tested to support the performance standard you require.
VGA	23' (7 m)	Use VGA cables with all pins in their connectors fully populated and wired.
Stereo 3.5 mm	20' (6 m)	Use only shielded 3.5 mm cables  <b>⚠ Important</b> Use only a 3.5 mm stereo jack (15 mm long barrel) to connect to the display.
USB 2.0	16' (5 m)	Use a Hi-Speed (480 Mbps) USB 2.0 USB extender if the distance between the computer and the display is greater than 16' (5 m). For more information, see <i>USB extenders</i> on page 12.

<sup>1</sup>Located on the display's front connector panel.

<sup>2</sup>Input from an OPS PC module when installed in the display's accessory slot.

<sup>3</sup>The performance of cables longer than 23' (7 m) is highly dependent on the cable's quality.

Cable type	Maximum length	Recommendation
USB 3.0	9' (3 m)	SMART supports only installations that use directly connected video and USB cables, AC-powered extenders, or USB extenders purchased from SMART. You might be able to use higher-grade cables that exceed the recommended length. If you have problems with such a cable or an extender of any type, test the connection with a shorter cable before contacting SMART Support.
USB Type-C	6' 6" (2 m) for SuperSpeed 5Gbps cables	<p>USB-IF certified USB 3.2 Gen 1 Type-C cable, SuperSpeed (5 Gbps) support</p> <p>To use a USB Type-C cable for video, you need:</p> <ul style="list-style-type: none"> <li>• A full-featured cable that supports SuperSpeed 5Gbps (or faster) data rates.</li> <li>• A computer that supports Display Port Alternate Mode via USB Type-C</li> </ul> <p><b>Note</b></p> <p>The USB Type-C connector in the display's front connector panel can supply up to 15 W of power to connected devices.</p>

Using cables that exceed these maximum lengths may produce unexpected results, intermittent loss of picture, or degraded picture quality and USB connectivity.

### Sharing USB Type-B receptacles

The HDMI, VGA, and Display Port connectors on the rear connector panels (back of the display) all share a single USB Type-B receptacle on the rear, side panel. This means the touch system can be used with only one device connected to these video inputs.

The touch system can still be used with a device connected to USB Type-B receptacle even when one of the video connectors is connected to another display.

USB Type-B receptacle	Video connectors
Touch	<ul style="list-style-type: none"> <li>• HDMI 1</li> <li>• HDMI 2</li> <li>• VGA</li> <li>• Display Port</li> </ul>

## Connecting a SMART OPS PC module

If your organization has purchased a SMART OPS PC module, you or your organization's installers can install the OPS PC module in the display's accessory slot following the OPS PC module's installation instructions ([smarttech.com/kb/171775](http://smarttech.com/kb/171775) or [smarttech.com/kb/171544](http://smarttech.com/kb/171544)). You can then view the OPS PC module's input on the display.

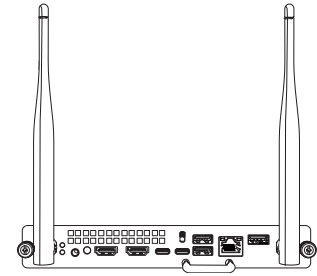

### **Caution**

Do not insert or remove the OPS PC from the accessory slot while the display is turned on.

For more information about SMART OPS PC modules, see the *SMART OPS PC modules user guide* ([smarttech.com/kb/171747](http://smarttech.com/kb/171747)).

# Connecting USB drives, peripherals, and other devices

The display includes two USB 3.2 Gen 1 Type-A receptacles on the front connector panel and two USB 3.2 Gen 1 Type-A receptacles on the side connector panel. You can connect USB drives, peripherals (such as keyboards), and other devices to the USB 3.2 Gen 1 Type-A receptacles and use these devices with the display's embedded OS or OPS slot computer. The display's USB 3.2 Gen 1 Type-A receptacles will switch to the active input.

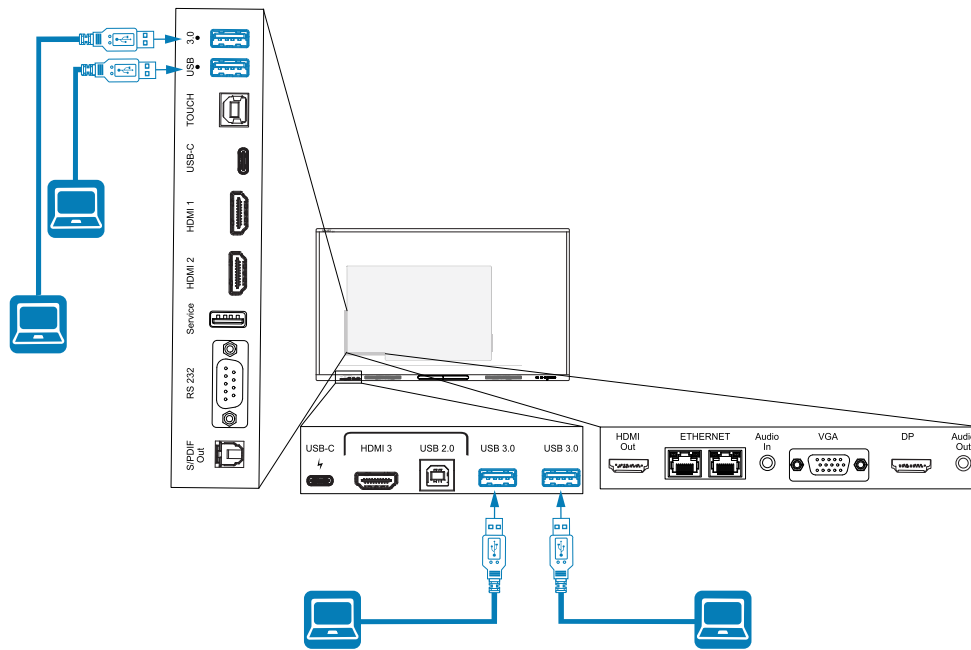



# Chapter 5 Troubleshooting the display

Resolving general issues .....	105
The display isn't turning on .....	106
The display is turning off when it shouldn't .....	106
The screen is blank or there's a problem with the image on the screen .....	107
There's no sound or there's a problem with the sound .....	109
Touch isn't working as expected .....	110
The pens aren't working as expected .....	111
SMART software on connected computers isn't working as expected .....	112
The SMART OPS PC module isn't working as expected .....	112
Contacting your reseller for additional support .....	112

This chapter explains how to resolve a variety of common issues with the display and the optional SMART OPS PC module. If the symptoms you're encountering aren't addressed below or the solutions don't work, refer to the SMART knowledge base for additional troubleshooting information.

[community.smarttech.com/s/topic/0TOU0000000kAJ0OAM/interactive-displays](http://community.smarttech.com/s/topic/0TOU0000000kAJ0OAM/interactive-displays)

## Resolving general issues

Symptom	Troubleshooting steps
You've forgotten the lock screen passcode or settings passcode.	Contact <a href="#">SMART Support</a> .
The display can't connect to a 5 GHz wireless network.	<p>The wireless network may be operating on bands that the display doesn't support. Contact your network administrator.</p> <p>Ensure both antennas are correctly installed on the display.</p> <p>Ensure Wi-Fi is enabled in the display's settings.</p> <p>See <i>SMART Board GX (V2) series interactive displays user's guide</i> (<a href="http://smarttech.com/kb/171862">smarttech.com/kb/171862</a>).</p> <p><b>Note</b></p> <p>The range of a 5 GHz wireless connection is more limited than that of a 2.4 GHz connection. 5 GHz connections are also more susceptible to interference from obstacles between the access point and the display, such as large metallic objects.</p>
The pen is broken.	Contact <a href="#">SMART Support</a> .
You need to identify the display.	See <i>Identifying your specific model</i> on page 10.

Symptom	Troubleshooting steps
An app is missing or not available.	<p>The app might not be included with the SMART Board GX (V2) series interactive display. See <i>Chapter 2 Using apps on the display</i> on page 27.</p> <p><b>Note</b></p> <p>Apps that require Google Play Services (such as the Google Play store) cannot be used on the display.</p>



## The display isn't turning on

Symptom	Troubleshooting steps
The status light isn't lit.	<ul style="list-style-type: none"> <li>Make sure the power cable is securely fastened to the power outlet and the display.</li> </ul> <p><b>Note</b></p> <p>If the power cable is connected to a power bar, make sure the power bar is securely connected to the power outlet and turned on.</p> <ul style="list-style-type: none"> <li>Make sure the switch beside the AC power inlet is in the ON (I) position.</li> <li>Make sure the power outlet is working by testing it with a different device.</li> <li>Make sure the power cable is working by testing it with a different device.</li> </ul>
The status light is lit red and the screen is blank.	<ul style="list-style-type: none"> <li>Press the <b>Power</b> button on the front of the display or on the remote control.</li> <li>Restart the display.</li> </ul>
The status light is lit blue, but the screen is blank.	<ul style="list-style-type: none"> <li>Wait up to 30 seconds, or press the <b>Power</b> button to determine if the problem is with an external video source.</li> <li>Press the <b>Home</b> button  on the front control panel. If the Home screen is displayed, check the external video source and connecting cables.</li> <li>Disconnect any cables from the display's HDMI Output connectors (if used) to determine whether equipment connected to the HDMI output port is causing the problem.</li> </ul>

## The display is turning off when it shouldn't

Symptom	Troubleshooting steps
The display turns off or enters Standby mode when it shouldn't.	<ul style="list-style-type: none"> <li>Check the timer switch settings in the <i>Startup and shutdown</i> section of the display's settings to see whether any <i>shutdown</i> tasks have been scheduled, and adjust them as needed.</li> </ul> <p>See the <i>SMART Board GX (V2) series interactive displays installation and maintenance guide</i> (<a href="http://smarttech.com/kb/171861">smarttech.com/kb/171861</a>).</p> <ul style="list-style-type: none"> <li>If the display is connected to a room control system via the RS-232 connection, disconnect it to determine if the problem is being caused by the room control system.</li> </ul>

# The screen is blank or there's a problem with the image on the screen

Symptom	Troubleshooting steps
<p>The screen is blank when the status light is blue.</p>	<ul style="list-style-type: none"> <li>• Make sure the screen is working by pressing the Home button  on the front control panel.</li> <li>• Make sure any connected computers are on and not in Standby mode.</li> <li>• Restart the display and any connected computers.</li> <li>• Replace the video cables that connect any computers to the display to determine if the issue is with the cables.</li> <li>• Ensure video cables that connect any computers to the display meet the recommended specifications. <i>See Using recommended cables on page 101.</i></li> <li>• Ensure that any connected computer's external video port is enabled, and is set to output a supported display resolution.</li> </ul> <p><b>Note</b> The recommended resolutions are 3140 × 2160 @ 60Hz or 1920 × 1080 @ 60Hz.</p>
<p>A computer is connected to the display, but only a "No signal" message appears on the screen.</p>	<ul style="list-style-type: none"> <li>• Make sure the computer is connected to the currently selected input.</li> <li>• If the currently selected input is a computer, make sure the computer is not in Standby mode.</li> <li>• If the currently selected input is a laptop, make sure that the laptop's external display port is enabled.</li> <li>• Ensure video cables that connect any computers to the display meet the recommended specifications. <i>See Using recommended cables on page 101.</i></li> </ul>
<p>The image on the screen is distorted. OR There are lines, snow or, other visual noise on the screen. OR The image is flickering or flashing. OR The image is dim.</p>	<ul style="list-style-type: none"> <li>• Press the Home button  on the front control panel. If the Home screen appears correctly, the issue is with the video input.</li> <li>• Switch to a different input and then back to the first input.</li> <li>• Make sure any connected computers are on and not in Standby mode.</li> <li>• Restart the display and any connected computers.</li> <li>• Make sure the computer's display output is configured to a recommended resolution and refresh rate for the display's inputs.</li> </ul> <p><b>Note</b> The recommended resolutions are 3140 × 2160 @ 60Hz or 1920 × 1080 @ 60Hz. <i>See Using recommended cables on page 101.</i></p> <ul style="list-style-type: none"> <li>• Replace the video cables that connect computers to the display to determine if the issue is with the cables.</li> <li>• Ensure video cables that connect computers to the display meet the recommended specifications. <i>See Using recommended cables on page 101.</i></li> </ul>

Symptom	Troubleshooting steps
There are bright spots on the screen.	<ul style="list-style-type: none"> <li>Press the Home button  on the front control panel. If it appears correctly, the issue is with the video input.</li> <li>Take a photograph of the screen and send it to SMART support. If SMART support determines that the issue is with the screen and the display is under warranty, you may be eligible for a replacement.</li> <li>Enable <i>Pixel shift</i> in the <i>System</i> section of the display's settings to reduce the risk of pixel burn-in when a static image is displayed for long periods. See the <i>SMART Board GX (V2) series interactive displays installation and maintenance guide</i> (<a href="http://smarttech.com/kb/171861">smarttech.com/kb/171861</a>).</li> </ul>
Colors don't appear correctly.	<ul style="list-style-type: none"> <li>Check the <i>Display</i> settings in Input settings (<b>Inputs &gt; Advanced settings &gt; Display</b>). See the <i>SMART Board GX (V2) series interactive displays installation and maintenance guide</i> (<a href="http://smarttech.com/kb/171861">smarttech.com/kb/171861</a>).</li> <li>Press the Home button to determine whether the color issue occurs on the Home screen only. If the Home screen appears normal but a specific video input does not, test the connection cables and video source equipment by temporarily replacing them.</li> <li>Be aware that if two or more displays are mounted side-by-side, there will be minor differences in colors across the displays. This issue is not unique to SMART products.</li> <li>If the screen is completely lacking one primary color (red, green, or blue) or the color problems occur on the Home screen, provide a photo of the screen to SMART support.</li> <li>If you're using the VGA analog video input, use a different cable or connect a different source to see if the issue is with the cable or input.</li> </ul>
The image is cut off or shifted to the left or right.	<ul style="list-style-type: none"> <li>Adjust any connected computer's video settings, particularly zoom, crop, and underscan. See the computer's operating system documentation.</li> <li>If any connected computers' desktops are entirely black, change them to dark gray or a different color.</li> <li>If any connected computers' desktops are extended across multiple screens, duplicate the desktops across the screens or set the display as the only screen.</li> </ul>
The image doesn't fill the entire screen.	<ul style="list-style-type: none"> <li>Adjust any connected computers' video settings, particularly overscan. See the computer's operating system documentation.</li> <li>Make sure the connected computer's video connector is configured to output a supported video signal. See <a href="#">No video display output from a laptop</a>.</li> </ul>
A persistent image appears on the display.	<ul style="list-style-type: none"> <li>See <a href="#">Image persistence or burn in on LCD displays</a>.</li> <li>Enable <b>Pixel shift</b> in the <i>System</i> section of the display's settings to reduce the risk of pixel burn-in when a static image is displayed for long periods. See the <i>SMART Board GX (V2) series interactive displays installation and maintenance guide</i> (<a href="http://smarttech.com/kb/171861">smarttech.com/kb/171861</a>).</li> </ul>
The video from a device connected to the display's USB Type-C connector doesn't appear on the display's screen.	<ul style="list-style-type: none"> <li>Make sure the connected device supports Display Port Alternate Mode via USB Type-C. If there is no <i>DP</i> logo beside the USB Type-C connector on the device, it might not support Display Port Alternate Mode.</li> <li>Make sure the cable connecting the device to the display supports SuperSpeed USB data speeds of 5 Gbps (or above). The cable should be marked with the SuperSpeed USB logo. The absence of this logo may indicate the cable doesn't support a SuperSpeed USB data connection that's required for Display Port Alternate Mode.</li> </ul>

Symptom	Troubleshooting steps
The image suddenly moves up and down, and then is stable again.	<ul style="list-style-type: none"> <li>This is normal behavior if the <i>Pixel shift</i> setting is enabled in the <i>System</i> section of the display's settings. This can help reduce the risk of screen burn-in when a static image is displayed for very long periods. Adjust the feature's timing, or turn off <i>Pixel shift</i> if this is undesirable.</li> </ul> <p>See the <i>SMART Board GX (V2) series interactive displays installation and maintenance guide</i> (<a href="http://smarttech.com/kb/171861">smarttech.com/kb/171861</a>).</p>

## There's no sound or there's a problem with the sound

Symptom	Troubleshooting steps
There's no sound. OR There is sound, but the volume is low. OR The sound is distorted or muffled.	<ul style="list-style-type: none"> <li>If you're using an external audio system, make sure it is turned on. Use of an external audio system must also be enabled in display settings.</li> </ul> <p>See the <i>SMART Board GX (V2) series interactive displays installation and maintenance guide</i> (<a href="http://smarttech.com/kb/171861">smarttech.com/kb/171861</a>).</p> <ul style="list-style-type: none"> <li>Make sure the cables connecting the display to the computer are securely fastened.</li> </ul> <div style="border-left: 2px solid #0070C0; padding-left: 10px; margin-left: 20px;"> <p><b>Notes</b></p> <ul style="list-style-type: none"> <li>The display's stereo 3.5 mm in connector works with the VGA input only.</li> <li>Connecting an audio cable to the display's stereo 3.5 mm out connector disables the internal speakers if the <i>Sound output settings</i> (<b>Display settings &gt; Input and output &gt; Audio output settings</b>) is set to <i>Auto</i>.</li> </ul> <p>See the <i>SMART Board GX (V2) series interactive displays installation and maintenance guide</i> (<a href="http://smarttech.com/kb/171861">smarttech.com/kb/171861</a>).</p> </div> <ul style="list-style-type: none"> <li>If you're using the display's stereo 3.5 mm out connector, adjust the volume on both the display and the connected computer and make sure neither is muted.</li> <li>Adjust the display's audio settings.</li> </ul> <p>See the <i>SMART Board GX (V2) series interactive displays installation and maintenance guide</i> (<a href="http://smarttech.com/kb/171861">smarttech.com/kb/171861</a>).</p> <ul style="list-style-type: none"> <li>If you're using the integrated speakers, set the volume for the computer and any running applications to 80%, and then adjust the display's volume.</li> </ul> <p>OR</p> <p>If you're using an external audio system, set the volume for the computer, any running applications, and the display to 80%, and then adjust the external audio system's volume.  </p>
There is a whine or buzzing sound coming from the back of the display.	<ul style="list-style-type: none"> <li>Be aware that these sounds are normal. All displays emit some electrical noise. Such sounds may be more noticeable with some displays than with others. However, if you hear noise from the front of the display, further investigation is required.</li> <li>Connect all devices to the same power outlet or power bar.</li> </ul>

# Touch isn't working as expected

Symptom	Troubleshooting steps
<p>The display doesn't respond to touch on the Home screen with no computer connected.</p>	<ul style="list-style-type: none"> <li>Remove infrared sources, such as incandescent or arc lights, desk lamps, and infrared audio devices, or move the display to another location in the room.</li> <li>Ensure that there are no physical obstructions (such as holiday decorations) on the display's frame.</li> <li>Restart the display. See the <i>SMART Board GX (V2) series interactive displays installation and maintenance guide</i> (<a href="http://smarttech.com/kb/171861">smarttech.com/kb/171861</a>).</li> </ul>
<p>The display doesn't respond to touch when viewing the input from a connected computer.</p>	<ul style="list-style-type: none"> <li>Make sure <a href="#">SMART Product Drivers 12.20</a> or later are installed and running on the connected computer.</li> <li>Make sure the USB cable between the display and the computer doesn't exceed the supported maximum cable length. See <i>Using recommended cables</i> on page 101.</li> <li>Make sure any connected computers have detected the display's USB connection and <a href="#">SMART Product Drivers 12.20</a> or later are installed.</li> <li>For Mac computers with macOS Mojave, ensure your MAC OS security settings allow the SMART Board to control applications. See <a href="#">How to resolve issues with installing and using SMART Learning Suite software on macOS Mojave</a>.</li> </ul>
<p>When viewing the image from a connected computer, the display responds to touch intermittently. OR When you touch the screen, the pointer doesn't appear in the correct place.</p>	<ul style="list-style-type: none"> <li>Restart the display. See the <i>SMART Board GX (V2) series interactive displays installation and maintenance guide</i> (<a href="http://smarttech.com/kb/171861">smarttech.com/kb/171861</a>).</li> <li>Make sure <a href="#">SMART Product Drivers and SMART Ink</a> are installed and running on any connected computers.</li> <li>Update SMART product drivers.</li> <li><a href="#">Update the firmware</a>.</li> <li>Confirm with the installers that the computer is connected to the display with only a single cable.</li> <li>Make sure the USB cable between the display and the computer doesn't exceed the maximum supported cable length. See <i>Using recommended cables</i> on page 101.</li> <li>Remove any USB extenders to help isolate the USB cable.</li> <li>If using USB extenders, ensure they support High Speed 480Mbps USB 2.0 (or faster) data rates.</li> <li>Make sure the video and USB cables that connect any computers to the display are connected using the correct connectors on the display.</li> <li>Remove infrared sources, such as sunlight, incandescent or arc lights, desk lamps, and infrared audio devices, or move the display to another location in the room.</li> </ul>

## The pens aren't working as expected

Symptom	Troubleshooting steps
<p>The display doesn't respond to touch or writing with a pen when viewing the input from a connected computer.</p>	<ul style="list-style-type: none"> <li>• Make sure any connected computers have detected the display's USB connection and <a href="#">SMART Product Drivers 12.20</a> or later are installed.</li> <li>• Make sure you are using the correct pens for the display, and are using an application that supports drawing with the pens.</li> <li>• Reinstall or update <a href="#">SMART Product Drivers and SMART Ink</a> on any connected computers.</li> <li>• Make sure the video and USB cables connecting any computers to the display are connected using the correct connectors on the display.</li> <li>• Make the sure the touch system is oriented to the correct display by orienting the display. See <a href="#">Orienting your SMART interactive product using SMART Product Drivers 12</a>.</li> <li>• Make sure the USB cable between the display and the computer doesn't exceed the supported maximum cable length. See <i>Using recommended cables</i> on page 101.</li> </ul>
<p>The display responds to touch but not to writing with a pen when viewing the image from a connected computer.</p>	<ul style="list-style-type: none"> <li>• Reinstall or update <a href="#">SMART Product Drivers and SMART Ink</a> on any connected computers.</li> <li>• Make sure you are using a SMART Board GX series interactive display pen.</li> <li>• Make sure <a href="#">SMART Product Drivers 12.20</a> or later is installed on any connected computers.</li> <li>• Make sure you are using the correct pens for the display, and are using an application that supports drawing with the pens.</li> </ul>
<p>When viewing the input from a connected computer and writing on the screen, the ink appears in the wrong place.</p> <p>OR</p> <p>Writing is intermittent.</p> <p>OR</p> <p>Ink disappears as you write.</p>	<ul style="list-style-type: none"> <li>• Restart the display.</li> <li>• Make sure <a href="#">SMART Product Drivers 12.20</a> or later is installed on any connected computers.</li> <li>• Orient the display. See <a href="#">Orienting your SMART interactive product using SMART Product Drivers 12</a>.</li> <li>• Remove infrared sources, such as sunlight, incandescent or arc lights, desk lamps, and infrared audio devices, or move the display to another location in the room.</li> <li>• <a href="#">Update the firmware</a>.</li> <li>• Avoid wearing any jewelry or other reflective objects when using the optical touch system.</li> <li>• Make sure that clothing or other objects are not touching the screen where you're touching or writing.</li> </ul>
<p>You can't write or draw in Microsoft Office when viewing the input from a connected computer.</p>	<ul style="list-style-type: none"> <li>• Make sure Microsoft Office 2013 or later is installed.</li> <li>• Reinstall or update <a href="#">SMART Product Drivers and SMART Ink</a>.</li> </ul>

## SMART software on connected computers isn't working as expected

Symptom	Troubleshooting steps
SMART Notebook software isn't working as expected.	See <a href="#">Troubleshooting SMART Notebook</a> .
Lumio by SMART isn't working as expected.	See <a href="#">Troubleshooting common issues in Lumio by SMART</a> .
SMART Ink isn't working as expected.	See <a href="#">Troubleshooting SMART Ink</a> .
SMART Product Drivers isn't working as expected.	See <a href="#">Troubleshooting SMART Product Drivers</a> .

## The SMART OPS PC module isn't working as expected

Symptom	Troubleshooting steps
The SMART OPS PC module isn't working as expected.	See the <i>SMART OPS PC modules user guide</i> ( <a href="http://smarttech.com/kb/171747">smarttech.com/kb/171747</a> ).

## Contacting your reseller for additional support

If an issue you're experiencing with the display persists or isn't addressed in this chapter or the knowledge base, contact your authorized SMART reseller ([smarttech.com/where](http://smarttech.com/where)) for support.

Your reseller might ask you for the display's serial number. The serial number is on a label on the left side of the display.

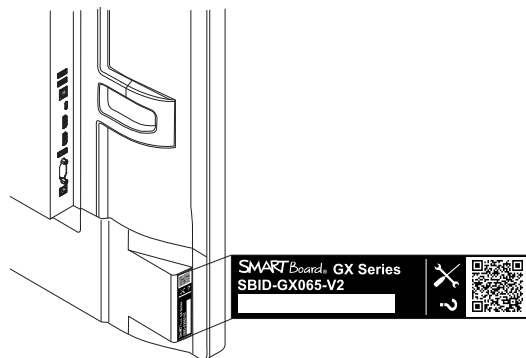



**Tip**

Scan the QR code on the label to view the SMART Board GX (V2) series interactive display support pages on the SMART website.

# Chapter 6 Troubleshooting tools and apps

Resolving issues with Whiteboard .....	114
Resolving issues with Browser .....	115
Resolving issues with Screen Share .....	116
Resolving issues with File Manager .....	117

## Note

For hardware troubleshooting information, see *SMART Board GX (V2) series interactive displays installation and maintenance guide* ([smarttech.com/kb/171861](http://smarttech.com/kb/171861)).

## Resolving issues with Whiteboard

Issue	Solutions
The pen doesn't write digital ink.	<ul style="list-style-type: none"> <li>Ensure the Pen tool is selected on the Whiteboard toolbar at the bottom of the screen.</li> <li>Make sure no other objects (such as your hand or clothing) are touching the screen close to the pen nib.</li> <li>A worn pen nib may act as a finger rather than a pen. Replacement pens are available from the Store for SMART Parts (see <a href="http://smarttech.com/Support/PartsStore">smarttech.com/Support/PartsStore</a>).</li> </ul>
Your finger draws ink instead of selecting an object.	Use the toolbar at the bottom of the Whiteboard app to change the active tool something other than Pen.
Multiple fingers draw multiple lines instead of performing pan, zoom, or rotate gestures.	Use the toolbar at the bottom of the Whiteboard app to change the active tool to Preview rather than Pen. You can also turn off Multiple-finger writing in settings (see <i>Settings</i> on page 30). See <i>SMART Board GX (V2) series interactive displays user guide</i> ( <a href="http://smarttech.com/kb/171862">smarttech.com/kb/171862</a> ).
You can't set an image as the background.	Tap <b>Menu &gt; Theme &gt; Background</b> and then press the + icon in the image section
The display can't open a saved Whiteboard.	Whiteboards are saved in .enb format. The file the display is trying to open might not be saved in a SMART Board GX (V2) Whiteboard file format.
The display can't open a SMART Notebook file.	The Whiteboard app on SMART Board GX (V2) series interactive displays doesn't support SMART Notebook files. Use SMART Notebook software on the connected computer to open a SMART Notebook file.

## Resolving issues with Browser

Issue	Solutions
Browser isn't working correctly.	<ul style="list-style-type: none"> <li>• Make sure the display is connected to a properly configured network and the network is connected to the internet. See <i>SMART Board GX (V2) series interactive displays installation and maintenance guide</i> (<a href="http://smarttech.com/kb/171861">smarttech.com/kb/171861</a>).</li> <li>• Make sure Ethernet or Wi-Fi is enabled in Settings under Network settings. See <i>SMART Board GX (V2) series interactive displays installation and maintenance guide</i> (<a href="http://smarttech.com/kb/171861">smarttech.com/kb/171861</a>).</li> <li>• If Browser can't visit secure (https) websites, ensure the display's date and time are correct. See <i>SMART Board GX (V2) series interactive displays installation and maintenance guide</i> (<a href="http://smarttech.com/kb/171861">smarttech.com/kb/171861</a>).</li> <li>• Browser doesn't support Flash or Java applets and will not function correctly if a web page features these objects.</li> <li>• Contact your network administrator.</li> </ul>
You can't find your downloads.	<ul style="list-style-type: none"> <li>• Check the Downloads folder in File Manager.</li> <li>• The display's storage might be full. Delete files or move them to a USB drive for backup.</li> </ul>
There is an issue with audio.	<ul style="list-style-type: none"> <li>• Make sure the volume isn't muted on the display's remote control. See <i>Using the remote control</i> on page 15. See <i>SMART Board GX (V2) series interactive displays user guide</i> (<a href="http://smarttech.com/kb/171862">smarttech.com/kb/171862</a>).</li> <li>• Turn up the volume. See <i>Using the front control panel</i> on page 14. See <i>SMART Board GX (V2) series interactive displays user guide</i> (<a href="http://smarttech.com/kb/171862">smarttech.com/kb/171862</a>).</li> </ul>
When using Lumio in the display's browser, writing or drawing in digital ink performs erratically.	<p>Writing or drawing in digital ink is not optimized for use in Lumio by SMART within the display's browser. You might want to use the split screen widget to simultaneously create notes in a Whiteboard file while viewing Lumio in the browser.</p> <p>See <i>Using the Split screen widget</i> on page 87.</p>

# Resolving issues with Screen Share

Issue	Solutions
Touchback isn't working.	<p>Make sure:</p> <ul style="list-style-type: none"> <li>• you are using the Bytello Share app to connect to the display.</li> <li>• Touchback is enabled for your device in <b>Device management</b>.</li> </ul> <p>Touchback is unavailable:</p> <ul style="list-style-type: none"> <li>• when another device is casting with Desktop Sync.</li> <li>• on mobile devices (Android and iOS) due to system limitations.</li> </ul> <p><b>Note</b></p> <p>When using Miracast on Android, the person at the display can interact with the device's screen.</p> <ul style="list-style-type: none"> <li>• when the screen is in floating window mode.</li> </ul>
YouTube doesn't show the screen when using AirPlay.	<p>Due to content protection, YouTube cannot display the screen. For the best user experience, connect to the display with the Bytello Share app.</p>
YouTube video doesn't play after an ad when using AirPlay.	<p>Live videos time out after 10 seconds and are not available for playback when screen sharing. If the video has ads, tap or click <b>Skip Ad</b> or <b>Next</b> from your device to start playback (the display does not have this option).</p>
I can't control the audio from the display on YouTube when using AirPlay.	<p>Due to system limitations, YouTube does not allow for audio control at the display when connect with AirPlay. Use the AirPlay media control instead. For the best user experience, connect to the display with the Bytello Share app.</p>
Browser doesn't play sound when casting from MacOS via Webcast.	<p>Check that your browser has permission to access audio. For the best user experience, connect to the display with the Bytello Share app.</p>
Chromebook doesn't play sound during sharing.	<p>Due to system limitations, Chromebook cannot play the sound from the display during screen sharing. The sound comes from the device. For the best user experience, connect to the display with the Bytello Share app.</p>
The display's screen share code doesn't appear in the list of available devices.	<p>Make sure the network is configured properly. See <i>SMART Board GX (V2) series interactive displays installation and maintenance guide</i> (<a href="http://smarttech.com/kb/171861">smarttech.com/kb/171861</a>).</p>
Your device or computer can't connect to the display.	<ul style="list-style-type: none"> <li>• Make sure your computer or device is on the same network as the display.</li> <li>• Make sure the network is configured properly. See <i>SMART Board GX (V2) series interactive displays installation and maintenance guide</i> (<a href="http://smarttech.com/kb/171861">smarttech.com/kb/171861</a>).</li> <li>• Make sure that your sharing device is on the same network subnet as the display.</li> <li>• If you're using the Bytello Share app, use the alphanumeric code shown on the display.</li> <li>• If you're using Apple AirPlay or Google Chromecast, look for the <i>ScreenShare####</i> name you can see on the display when you expand the screen share window.</li> <li>• Make sure your computer or device is on the same subnet as the display. Contact your network administrator.</li> <li>• Make sure the Bytello Share app is installed on your device. See <i>Chapter 6 Troubleshooting tools and apps</i> on page 114</li> </ul>

Issue	Solutions
No sound is heard from your shared device.	<ul style="list-style-type: none"> <li>• Make sure your device isn't muted.</li> <li>• Turn up the device's volume.</li> <li>• Turn up the display's volume. See <i>Using the front control panel</i> on page 14.</li> <li>• Make sure that the display's speakers are enabled in the display's settings. See <i>SMART Board GX (V2) series interactive displays installation and maintenance guide</i> (<a href="http://smarttech.com/kb/171862">smarttech.com/kb/171862</a>).</li> </ul>



## Resolving issues with File Manager

Issue	Solutions
You can't open files using File Manager.	<ul style="list-style-type: none"> <li>• Make sure an app is installed on the display that supports the file type you're trying to open.</li> </ul>
You can't read from or write to a connected USB drive.	<ul style="list-style-type: none"> <li>• Connect the drive to the USB port for the display. See <i>Connecting USB drives, peripherals, and other devices</i> on page 104.</li> <li>• Make sure the USB drive is FAT formatted.</li> <li>• Make sure the USB drive isn't encrypted or partitioned.</li> <li>• The USB drive is full. Delete files before copying more files onto it.</li> </ul>
You can't recover deleted files.	Recovery of deleted files is not supported.

# Certification and compliance

## Accessing the display's e-label information

An electronic (e-label) version of the GX (V2) display's regulatory information is available in the display's settings.

From the Home screen, tap the **Apps** icon  > **Settings** icon  > **Regulatory Information**.

For more information, see the *SMART Board GX (V2) series interactive displays user guide* ([smarttech.com/kb/171862](http://smarttech.com/kb/171862))

## Federal Communication Commission interference statement

### FCC

#### Supplier's Declaration of Conformity

#### 47 CFR § 2.1077 Compliance Information

#### Unique Identifier: IDGX65-2, IDGX75-2, IDGX86-2

#### Responsible Party – U.S. Contact Information

SMART Technologies Inc.

2401 4th Ave, 3rd Floor

Seattle, WA 98121

[compliance@smarttech.com](mailto:compliance@smarttech.com)

This device complies with Part 15 of the FCC Rules. Operation is subject to the following two conditions:

1. This device may not cause harmful interference, and
2. this device must accept any interference received, including interference that may cause undesired operation.

### Note

This equipment has been tested and found to comply with the limits for a Class A digital device, pursuant to part 15 of the FCC Rules. These limits are designed to provide reasonable protection against harmful interference when the equipment is operated in a commercial environment. This equipment generates, uses, and can radiate radio frequency energy and, if not installed and used in accordance with the instruction manual, may cause harmful interference to radio communications. Operation of this equipment in a residential area is likely to cause harmful interference in which case the user will be required to correct the interference at his own expense.

### **Caution**

Any changes or modifications not expressly approved by the party responsible for compliance could void the user's authority to operate this equipment.

### **Restriction**

Operations in the 5.15-5.25 GHz band are restricted to indoor usage only.

IEEE 802.11b or 802.11g operation of this product in the USA is firmware limited to channels 1 through 11.

### **Radiation exposure statement**

This equipment complies with FCC radiation exposure limits set forth for an uncontrolled environment. This equipment should be installed and operated with minimum distance of 20 cm between the antenna of this device and all nearby persons. This transmitter must not be co-located or operated in conjunction with any other antenna or transmitter.

## Innovation, Science and Economic Development Canada statement

This device complies with RSS-210 of the Innovation, Science and Economic Development Canada Rules. Operation is subject to the following two conditions:

1. This device may not cause harmful interference, and
2. this device must accept any interference received, including interference that may cause undesired operation.

### **Caution**

(i) the device for operation in the band 5150-5250 MHz is only for indoor use to reduce the potential for harmful interference to co-channel mobile satellite systems;

(ii) the maximum antenna gain permitted for devices in the bands 5250-5350 MHz and 5470-5725 MHz shall comply with the e.i.r.p. limit; and

(iii) the maximum antenna gain permitted for devices in the band 5725-5825 MHz shall comply with the e.i.r.p. limits specified for point-to-point and non point-to-point operation as appropriate.

(iv) Users should also be advised that high-power radars are allocated as primary users (i.e., priority users) of the bands 5250-5350 MHz and 5650-5850 MHz and that these radars could cause interference and/or damage to LE-LAN devices.

## Troubleshooting tools and apps

### Radiation exposure statement

This equipment complies with ISED radiation exposure limits set forth for an uncontrolled environment. This equipment should be installed and operated with minimum distance of 20 cm between the antenna of this device and all nearby persons. This transmitter must not be co-located or operated in conjunction with any other antenna or transmitter.

## Innovation, Science et Développement économique Déclaration du Canada

Cet appareil est conforme à la norme ISED CNR-210 pour les appareils radio agréés. Son fonctionnement est soumis aux deux conditions suivantes:

1. le dispositif ne doit pas produire de brouillage préjudiciable, et
2. ce dispositif doit accepter tout brouillage reçu, y compris un brouillage susceptible de provoquer un fonctionnement indésirable.

### Avertissement

(i) les dispositifs fonctionnant dans la bande 5 150-5 250 MHz sont réservés uniquement pour une utilisation à l'intérieur afin de réduire les risques de brouillage préjudiciable aux systèmes de satellites mobiles utilisant les mêmes canaux;

(ii) le gain maximal d'antenne permis pour les dispositifs utilisant les bandes 5 250-5 350 MHz et 5 470-5 725 MHz doit se conformer à la limite de p.i.r.e.;

(iii) le gain maximal d'antenne permis (pour les dispositifs utilisant la bande 5 725-5 825 MHz) doit se conformer à la limite de p.i.r.e. spécifiée pour l'exploitation point à point et non point à point, selon le cas.

(iv) De plus, les utilisateurs devraient aussi être avisés que les utilisateurs de radars de haute puissance sont désignés utilisateurs principaux (c.-à-d., qu'ils ont la priorité) pour les bandes 5 250-5 350 MHz et 5 650-5 850 MHz et que ces radars pourraient causer du brouillage et/ou des dommages aux dispositifs LAN-EL.

### Déclaration d'exposition aux radiations

Cet équipement est conforme aux limites d'exposition aux rayonnements ISED établies pour un environnement non contrôlé. Cet équipement doit être installé et utilisé avec un minimum de 20 cm de distance entre la source de rayonnement et votre corps. Cet émetteur ne doit pas être co-implantés ou exploités conjointement avec une autre antenne ou émetteur.

## EU Declaration of Conformity

Hereby, SMART Technologies ULC declares that the radio equipment type Interactive Display **IDGX65-2**, **IDGX75-2**, **IDGX86-2** and the **PCM11** are in compliance with Directive 2014/53/EU.

The full text of the EU declaration of conformity is available at the following Internet address: [smarttech.com/compliance](http://smarttech.com/compliance)

### Warning

Operation of this equipment in a residential environment could cause radio interference.

The frequency band and the maximum transmitted power in EU are listed below:

Regulatory models: IDGX65-2, IDGX75-2, IDGX86-2

Transmitting Band (MHz)	Maximum Transmit Power dBm
2402-2483.5	16
5150-5350	15
5470-5725	15.5
5725-5850	12

Regulatory model: PCM11

Transmitting Band (MHz)	Maximum Transmit Power dBm
2402-2483.5	20
5150-5350	23
5470-5725	23
5725-5850	13.9

Restrictions in:

AT/BE/BG/CZ/DK/EE/FR/DE/IS/IE/IT/EL/ES/CY/LV/LI/LT/LU/HU/MTNL/NO/PL/PT/RO/SI/SK/TR/FI/SE/CH/UK/HR – 5150MHz-5350MHz is for indoor use only.

For optimal performance any support equipment connected to this device must be CE compliant.

## Hardware environmental compliance

SMART Technologies supports global efforts to ensure that electronic equipment is manufactured, sold, and disposed of in a safe and environmentally friendly manner.

### Waste Electrical and Electronic Equipment (WEEE)

Electrical and electronic equipment and batteries contain substances that can be harmful to the environment and to human health. The crossed-out wheeled bin symbol indicates that products should be disposed of in the appropriate recycling stream and not as regular waste.



## Troubleshooting tools and apps

**Batteries** The display contains a CR2032 coin cell battery. The remote contains two AAA batteries. Recycle or dispose of batteries properly.

---

**Perchlorate material** The coin cell battery contains perchlorate material. Special handling may apply. See [dtsc.ca.gov/hazardouswaste/perchlorate](http://dtsc.ca.gov/hazardouswaste/perchlorate).

---

**More information** See [smarttech.com/compliance](http://smarttech.com/compliance) for more information.



**SMART Technologies**

[smarttech.com/support](https://smarttech.com/support)

[smarttech.com/contactsupport](https://smarttech.com/contactsupport)

[smarttech.com/kb/171862](https://smarttech.com/kb/171862)